



# **Electric Power Application and Installation Guide**

## **Engine and Generator Sizing**

LEBX0026-01



WHERE THE WORLD TURNS FOR POWER



# Table of Contents

|  |    |
|--|----|
| Introduction .....                                 | 5  |
| Engine Rating Considerations .....                 | 5  |
| Rating Definitions .....                           | 5  |
| Load Management .....                              | 7  |
| Standards .....                                    | 7  |
| Site Conditions Impact on Genset Ratings .....     | 9  |
| Transient Response .....                           | 11 |
| Transient Response Standards .....                 | 14 |
| Customer Requirements .....                        | 19 |
| Power Demand .....                                 | 19 |
| Load Steps .....                                   | 22 |
| Demand Factor .....                                | 26 |
| Diversity Factor .....                             | 26 |
| Demand Factor and Diversity Factor in Sizing ..... | 27 |
| Starting Requirements .....                        | 28 |
| Performance .....                                  | 29 |
| Load Analysis .....                                | 31 |
| Lighting Loads .....                               | 32 |
| Motor Loads .....                                  | 34 |
| Motor Performance .....                            | 38 |
| Motor Starting Techniques .....                    | 45 |
| Miscellaneous Loads .....                          | 54 |
| Genset Selection Considerations .....              | 69 |
| Load Types .....                                   | 69 |
| Harmonic Content .....                             | 70 |
| Generator Considerations .....                     | 72 |
| Multi-Engine Installations .....                   | 78 |



# Engine and Generator Sizing

## Introduction

On-site engine-generator sets (gensets) are used in a variety of applications. They are becoming more popular for load management applications since the deregulation and privatization of the utility industry. Some gensets are used strictly as “back-up” for emergencies and some as the only power source.

Although computer programs can be used to assist in proper generator sizing, an understanding of the formulas and calculations to determine proper sizing and how other non-numerical factors can influence sizing are highlighted in this chapter.

Specifically, engine ratings, customers applications, load analysis, genset selection criteria, and multi-engine installations must all be taken into consideration.

## Engine Rating Considerations

### Rating Definitions

A generator set (genset) consists of an engine and a generator. However, it is best to consider the engine and generator as a system. Individually, each has unique characteristics; but together these qualities have a significant impact on the performance and sizing of the genset system.

Capabilities of both engine and generator are considered individually and collectively when selecting generator sets. Engines produce brake horsepower (or kilowatts) while controlling speed or frequency. Generators influence engine behavior, but are primarily responsible for changing engine power into kilovolt-amperes (kVA) and electrical kilowatts (kW). They also must satisfy high “magnetizing current” draws (kVAR), or transient conditions from electrical equipment.

Normally a generator set is furnished with a generator which matches the engine output capability. Engines are sized according to the actual power in kW required to meet the needs of the facility. The generator, on the other hand, must be capable of handling the maximum apparent power which is measured in kVA. There are several ways in which the actual power can be identified. It can be calculated by adding the nameplate ratings of the equipment to be powered by the generator. If this is done, the efficiencies of the equipment must also be considered. The actual power can be determined by performing a load analysis on the facility. This involves making a survey of the power requirements over a period of time.

$$ekW = pf \times kVA$$

$$bkW = \frac{ekW}{eff} + \text{Fan demand}$$

$$kVA = \text{kVA output of generator}$$

$$pf = \text{power factor of connected load}$$

$$ekW = \text{electrical power (electrical kW)}$$

$$bkW = \text{engine power (brake kW)}$$

$$eff = \text{generator efficiency}$$

When kW is neither qualified as electrical (ekW) or brake (bkW), it is important to clarify between the two when performing calculations or product comparisons.

### Engine — Generator Set Load Factor

Load factor of a generator set is used as one criterion for rating a genset. It is calculated by finding the product of various loads:

$$\% \text{ of time} \times \% \text{ of load}$$

$$\% \text{ of time} = \frac{\text{time at specific load}}{\text{total operating time}}$$

$$\% \text{ of load} = \frac{\text{specific load}}{\text{rated load}}$$

Extended idling time and the time when the generator set is not operating does not enter into the calculation for load factor.

For example, assume a facility has a genset rated at 550 kW and runs it two hours a week. During those two hours it runs at 400 kW for 1½ hours. Find the load factor.

Using the formulas we find:

$$\begin{aligned} \% \text{ of Load} &= 400 \text{ kW} / 550 \text{ kW} = 0.73 \\ \% \text{ of Time} &= 90 \text{ min} / 120 \text{ min} = 0.75 \\ \text{Load Factor} &= 0.73 \times 0.75 = 54.75\% \end{aligned}$$

This load factor would indicate that the genset could be used as a standby rated genset because it meets the load factor and other criteria of standby.

Rating definitions for Caterpillar Generator sets are based on typical load factor, hours of use per year, peak demand and application use. Caterpillar Genset Ratings are as follows:

### Standby Rating

Output available with varying load for the duration of the interruption for the normal power source.\*

- Typical Load Factor = 60% or less
- Typical Hours per Year = 500 hours
- Typical Peak Demand = 80% of standby rated kW with 100% of rating available for the duration of an emergency outage.
- Typical Application = Building Services standby and enclosed/sheltered environment.

### Prime Rating

Output available with varying load for an unlimited time.\*\*

- Typical Load Factor = 60% to 70%
- Typical Hours per Year = no limit
- Typical Peak Demand = 100% of prime rating used occasionally.
- Typical Application = industrial, pumping, construction, peak shaving or cogeneration.

### Continuous Rating

Output available without varying load for an unlimited time.\*\*\*

- Typical Load Factor = 70% to 100%
- Typical Hours per Year = no limit
- Typical Peak Demand = 100% of continuous rating used 100% of the time.
- Typical Application = base load, utility, cogeneration, parallel operation.

*Operating above these rating definitions will result in shorter life and higher generating costs per year.*

- \* Fuel Stop Power in accordance with ISO 3046/1, AS2789, DIN6271, and BS5514.
- \*\* Prime Power in accordance with ISO 8528. Overload Power in accordance with ISO 3046/1, AS2789, DIN6271, and BS5514.
- \*\*\* Continuous Power in accordance with ISO 8528, ISO 3046/1, AS2789, DIN6271, and BS5514.

The International Standards Organization (ISO) 8528-1 defines three types of duty:  
Continuous Operating Power (COP)  
Prime Running Power (PRP)  
Limited-Time running Power (LTP)

### Continuous Operating Power (COP)

Continuous operating power is the power a generator set can operate at a *continuous* load for an unlimited number of hours under stated ambient conditions. Maintenance according to the manufacturer must be followed to reach these standards.

### Prime Running Power (PRP)

Prime running power is the maximum power a generator set has during a *variable* power sequence for an unlimited number of hours under stated ambient conditions. Maintenance according to the manufacturer must be followed to reach these standards.

### Limited-Time Running Power (LTP)

Limited-time running power is the *maximum* power that a generator set delivers for up to 500 hours per year under stated ambient conditions. Only 300 hours can be continuous running. Maintenance according to the manufacturer must be followed to reach these standards.

Many times specifications will be written with ISO standards in mind. The following chart matches Caterpillar genset ratings to ISO genset ratings.

|                |     |                        |
|----------------|-----|------------------------|
| ISO<br>Ratings | vs. | Caterpillar<br>Ratings |
| LTP            |     | Standby                |
| COP            |     | Continuous             |
| PRP            |     | Prime                  |

## Load Management

Load management is the deliberate control of loads on a genset and/or utility so as to have the lowest possible electrical costs. In addition, Caterpillar has two broad rating categories in terms of load management: isolated from a utility and paralleled with a utility.

### Load Management when Isolated from the Utility Under 750 Hours per Year:

Output available with varying load for less than 6 hours per day\*.

Typical Load Factor = 60% or less

Typical Hours per Year = less than 750 hours

Typical Peak Demand = 80% of rated kW with 100% of rating available for duration of an emergency outage.

Typical Application = interruptible utility rates, peak sharing.

### Load Management when Isolated from the Utility Over 750 Hours per Year:

Output available without varying load for over 750 hours per year and less than 6 hours per day.\*\*

Typical Load Factor = 60% to 70%

Typical Hours per Year = more than 750 hours

Typical Peak Demand = 100% of prime plus 10% rating used occasionally.

Typical Application = peak sharing or co-generation.

### Load Management when Paralleled with the Utility Under 750 Hours per Year:

Output available without varying load for under 750 hours per year.

Typical Load Factor = 60% to 70%

Typical Hours per Year = less than 750 hours

Typical Peak Demand = 100% of prime rating used occasionally.

Typical Application = peak sharing.

### Load Management when Paralleled with the Utility Over 750 Hours per Year:

Output available without varying load for unlimited time.\*\*\*

Typical Load Factor = 70% to 100%

Typical Hours per Year = no limit

Typical Peak Demand = 100% of continuous rating used 100% of the time.

Typical Application = base load, utility, peak sharing, cogeneration, parallel operation.

\* Fuel Stop Power in accordance with ISO 3046/1, AS2789, DIN6271, and BS5514

\*\* Prime Power in accordance with ISO 8528. Overload Power in accordance with ISO 3046/1, AS2789, DIN6271, and BS5514.

\*\*\* Continuous Power in accordance with ISO 8528, ISO 3046/1, AS2789, DIN6271, and BS5514

Depending on how the genset will be applied will determine the size needed. For example, if for a given load, the genset will only be used as standby for a critical load only, then a smaller kW genset can be used than one used for prime power.

## Standards

Caterpillar generator sets are in accordance with The International Standardization Organization (ISO) and the Society for Automotive Engineers (SAE) standards. Each organization uses different techniques and tolerances for power ratings and fuel consumption.

ISO standard 3046-1 is specific to engines and ISO 8528 is followed for the generator set.

ISO 8528 has 12 sections. Section 1 describes applications, ratings and performance. A complete listing of the contents of all chapters are listed below.

| Section | Topic  |
|---------|--|
| 2       | Specifies characteristics of engines                               |
| 3       | Alternating current generators                                     |
| 4       | Control gear & switchgear specifications                           |
| 5       | Generating set specifications                                      |
| 6       | Specifies test methods   |
| 7       | Technical declarations for specification and design                |
| 8       | Low power generator sets   |
| 9       | Requirements on measurement and evaluation of mechanical vibration |
| 10      | Standards for noise  |
| 11      | Dynamic, uninterrupted power supply systems                        |
| 12      | Emergency power supply to safety services                          |

## Generator Rating Capability

Gensets are limited in their ratings by the conditions and applications of both the generator and engine.

Generator ratings are typically thermal limited. They are limited by how much internal heat is created and the amount that is then dissipated. A more precise definition is the increase in winding temperature above the ambient temperature. In other words, some heat is retained within the unit, raising the temperature of the unit. The NEMA generator ratings are based on the generators “temperature rise” limit. Outside the United States, the International Electrotechnical Commission (IEC) have limits on temperature rise for generators found in 34-22 and 34-1.

**Temperature rise is the increase in winding temperature above the ambient temperature** (ambient temperature, recall, is the temperature of the cooling air as it enters the ventilating openings of the machine). This temperature rise occurs because of the flow of current in the windings and internal losses that occur in the machine during operation.

The most common classes of generators are the “F” & “H” class. For all classes, NEMA assumes operation at 40°C ambient or lower. The temperature rise limits also allow for a 10°C margin for hot-spots. A hot-spot is the spot in stator windings with the highest temperature.

| Generator Class | Temperature Rise | Genset Package Rating |
|-----------------|------------------|-----------------------|
| F<br>H          | 80<br>—          | Continuous            |
| F<br>H          | 105<br>125       | Prime<br>Prime        |
| F<br>H          | 130<br>150       | Standby<br>Standby    |

Table 1. Class vs. Rise

For prime power, the “F” class has a 105°C rise or total temperature limit of 155°C (40°C ambient temperature + 10°C hot-spot margin + 105°C temperature rise) or less. The “H” class allows for a 125°C rise or total temperature limit of 175°C or less (40°C + 10°C + 125°C).

For standby power, the “F” class has a 130°C temperature rise limit or 180°C total temperature (40°C + 10°C + 130°C). The “H” class has a 150°C temperature rise or 200°C total temperature limit.

Voltage plays a key role in generator rating and, therefore, must be considered. In some cases, generator voltage will not match the preferred operating voltage. The voltage regulator provides voltage adjustment capability. However, when “dialing down” generator voltage the current will increase for a given rating, increasing generator heat and may require generator derating. An alternative to accepting the derate when dialing down is to use a larger generator to maintain the standard rating.

NEMA has set the standard that a generator can be adjusted up or down  $\pm 5\%$  as installed. Caterpillar generators typically have a minimum 10% dial down capability. In some cases this may result in a derate. Some generators are specifically designed as broad range and may not require derating. A check of manufacturer’s data is recommended when using generators at “off-design” voltage.

## Generator Mapping Limits

The following chart is an operational chart for a salient-pole generator. A load point within this area defines the active, reactive, and apparent powers, the current, power factor, and excitation. The heavy dark line (mnpsqt) indicates absolute limits that are tolerated in a machine. Generators are rated within these limits. (See Generator Section for additional details.)

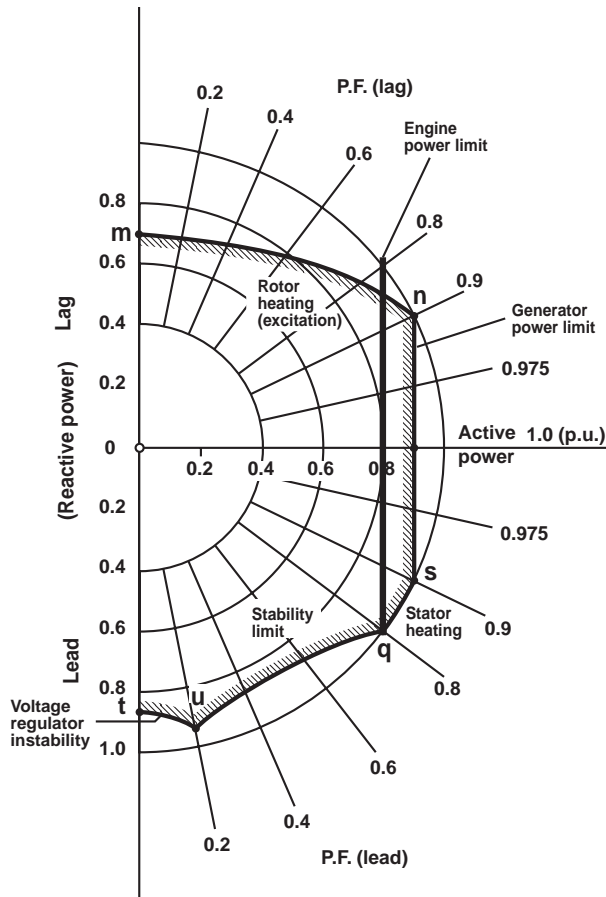

Figure 1. Generator Map for Salient-Pole Generator.

## Site Conditions Impact on Genset Ratings

An engine rating is primarily limited by structural and thermal limits. These limits include maximum cylinder pressure during combustion, turbocharge speed and exhaust gas temperature. Where an engine operates relative to these limits will determine the maximum altitude and ambient temperature for a given rating. When an engine exceeds the maximum altitude or ambient temperature, the engine must be derated.

The environment or site conditions also impact an engine or generator rating, thus impacting the rating of the entire genset. Conditions which may affect a rating include altitude, temperature, corrosive atmospheres, humidity, and dust.

Altitude and temperature most heavily influence engine ratings. The higher the altitude, the lower the air density. Clean dense air is needed for efficient combustion. Likewise, an increase in temperature lowers air density. Therefore, a derate of the engine must occur in high altitude and/or high temperature conditions in order for the genset to meet performance expectations.

**Altitude:** Altitudes above 1000 M (3281 ft.) require temperature rise reduction of 1% for every 100 M (328 ft.) above base (1000 M or 3281 ft.). A derate chart is available in TMI for generators and each specific engine.

In general, the derate chart shows the engine derates more rapidly than the generator. At a given altitude over 1000 M (3281 ft.), the flywheel horsepower output will be lower for a generator.

```

3406C   DI TA JW   DRY  MANF  TURBO QTY 1       HYDRA GOV
DM2272-01 PGS PRIME      50  HERTZ
GEN  292.0 W/F EKW  302.0 W/O F EKW      W/F BHP  433 W/O F BHP @ 1500 RPM

INFO CODE 06 - ALTITUDE CAPABILITY DATA * * * * *
AMBIENT OPERATING TEMPERATURE
  DEG F =>    50      68      86      104      122  NORMAL
ALTITUDE - FT * * * *  MAXIMUM SET GROSS ENGINE POWER - BHP * * * *

    0          433      433      433      433      433      433
   984        433      433      433      433      433      433
  1640        433      433      433      433      433      433
  3281        433      433      433      432      418      433
  4921        433      433      420      406      394      433
  6562        422      409      396      382      370      412
  8202        397      384      371      359      349      392
  9843        373      361      349      337      327      371
 11483        350      338      327      316      307      353
 13123        329      316      306      296      287      334
 14764        307      296      287      278      270      316
 16404        287      278      268      260      252      300
 18045        268      259      251      243      235      284
 19685        251      241      235      227      220      268

PRESS <ENTER> FOR ADDITIONAL DATA
                NEXT TRAN: INFO CODE ( 06 ) UNIT TYPE ( E )
HLP-F1 ACF-F3 PGM-F4 INQ-F5                IDX-F9

```

Figure 2. TMI Sample

**Heat:** Where the temperature of the ventilating air to the generator exceeds 40°C (104°F), derating of the generator may be necessary. The altitude/temperature derating chart found in TMI can be used for proper derating information.

**Corrosive Atmospheres:** Salt and other corrosive elements can cause damage to the winding insulation which can lead to failure of the generator. Protection from these elements include additional coatings of insulation on the windings during the manufacturing process and epoxy compounds as a final winding overcoat.

**Humidity:** Condensation resulting from humidity can present a problem for standby units, units infrequently run, or units in storage. Temperature rise of the machine and the circulation of cooling air during operation is usually sufficient in preventing condensation. Space heaters can be used to raise the temperature to 5°C above the ambient temperature to prevent condensation in high humidity areas.

**Dust:** Conductive or abrasive dust drawn in through the cooling fan can be very harmful to the generator. Examples of abrasive dust are: cast iron dust, carbon dust, sand, powdered graphite, coke dust, lime dust, wood fiber, and quarry dust. Deposits of these materials in the air gap and/or resulting insulation abrasion from them can cause an electrical short which will destroy the generator. Filters which fit over the unit's intake air openings or enclosure ventilation openings can prevent damage. When using filters it is important that they are regularly changed so as not to impede air flow. Use of a generator air filter often causes the generator to be derated due to higher temperature rise resulting from reduced cooling air flow.

## Transient Response

Whenever a load is applied to or removed from a generator set, the engine speed rpm, voltage and frequency are temporarily changed from its *steady-state condition*. This temporary change is called *transient response*. When a significant load is applied, the engine speed temporarily reduces (generally referred to as *frequency or voltage dip*) and then returns to its steady-state condition. The degree of this dip depends on the amount of active power (kW) and reactive power (kV) changes based upon total capacity and dynamic characteristics of the generator set. On removal of load, the engine speed increases momentarily (generally referred to as overshoot), then returns to its steady-state condition. The time required for the generator set to return to its normal steady-state speed is called *recovery time*. This is illustrated graphically below.

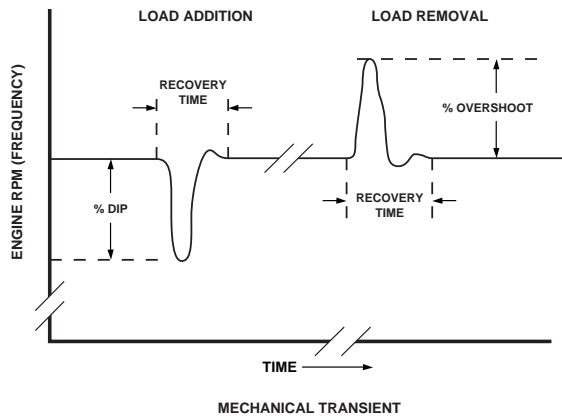

Figure 3.

## Sizing Criterion

Three criteria need to be provided to accurately size a generator set:

1. The acceptable percent of voltage & frequency dip
2. The acceptable duration of the voltage & frequency dip
3. The percent and type of load to be connected

## Motor Starting

The genset's ability to start large motors without large frequency or voltage dips depends on the entire system. System factors include:

- Available engine power
- Capacity of the generator
- Energy stored in the rotating inertia of the genset
- Acceleration of the motor and its load (motor characteristics).

A properly sized generator will support the high starting kVA (skVA) required and sustain adequate output voltage for the motor so it can produce the needed torque to accelerate its load to rated speed.

After the initial voltage dip it is important that the generator restore voltage to at least 90% to develop adequate torque to accelerate its load to rated speed. Full voltage starting causes the largest voltage dip. For this reason, public utilities will not always allow full voltage starting of large motors. Details on motor starting are later discussed in the "load analysis" section of this chapter.

Transient response of a genset is a description of the maximum voltage and frequency change on application of a load and the time to recover to nominal voltage and frequency conditions. Typically the maximum allowable voltage dip is 30%. The maximum frequency dip is about 25% but modern equipment is restricting this to tighter margins.

Gensets all perform differently by the design of the engine, governing, and voltage regulation systems. When it comes to transient response, the issue isn't always to get the quickest response, but the best response which is applicable to the need. Comparisons of the transient response characterizations and the equipment that will be used at the facility need to be made to accurately size the genset to the loads that will be applied.

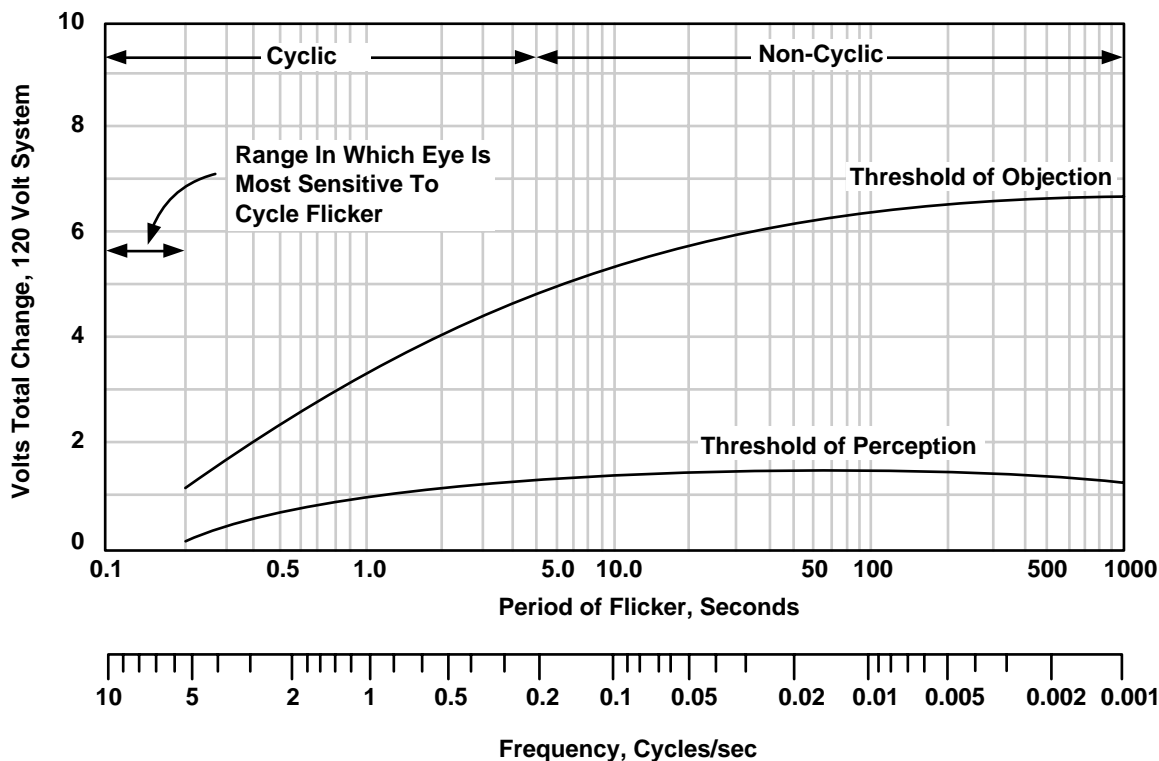

Figure 4.

The larger the voltage dip a generator set can tolerate, the smaller and perhaps more economical the generator set can be. A 30% maximum voltage dip is standard for a Caterpillar generator set. Sensitive loads may be written in spec for much lower voltage dips. UPS, variable speed drives, and medical equipment are all examples of loads which need small voltage dips.

Typical voltage dip limitations are found on the chart below for various facilities.

| Typical Voltage Dip Limitations  |   |                     |
|--|---|---------------------|
| Facility   | Application   | Permissible Voltage |
| <b>Dip</b>   |   |                     |
| Hospital, hotel motel, apartments, libraries, schools, and stores.             | Lighting load, large Power load, large Flickering highly objectionable. | 2% Infrequent       |
| Movie Theaters (sound tone requires constant frequency. Neon flashers erratic) | Lighting load, large Flickering objectionable.                          | 3% Infrequent       |
| Bars and resorts.  | Power load, large Some flicker acceptable                               | 5% - 10% Infrequent |
| Shops, factories, mills, laundries.  | Power load, large Some flicker acceptable                               | 3% - 5% Frequent    |
| Mines, oil field, quarries, asphalt, plants.                                   | Power load, large Flicker acceptable.                                   | 25% - 30% Frequent  |

Table 2.

\*Greater voltage fluctuations permitted with emergency power systems

The human eye is sensitive to slight lighting fluctuations. Even a decrease of 1/2 volt on a 110 volt incandescent bulb is noticeable. A one volt dip, if repeated, becomes objectionable. Figure 4 shows the range of observable and objectionable voltage dips, assuming direct illumination and medium-sized bulbs.

If indirect lighting is used with no incandescent bulbs below 100 watts, these values may be broadened. This is also true if all lighting is fluorescent rather than incandescent.

Reciprocating compressors seriously affect lighting quality. Torque pulsations vary motor current, causing sufficient voltage fluctuation to flicker lights. Unfortunately, this is a frequency to which eyes are extremely sensitive.

A commonly accepted figure for current variation limits for motor-driven reciprocating compressors is 66% of full rated motor current. This limits horsepower rating of compressor motors to about 6% of generator kVA rating, which is in the limit of objectionable light flicker. For example, a 30 hp motor may be used on systems having not less than 500 kVA of generator capacity in operation (30 is 6% of 500).

### **Block Load**

A block load refers to the percentage of rated power at rated power factor instantaneously added to the genset. When block loads are large, sometimes they should be accepted in smaller portions in various steps. Step loading is very common when load acceptance performance criteria are required. For example, if a genset is rated 1000 ekW at 0.8 pf and a 250 ekW load at 0.8 pf is applied to the genset, a block load of 25% [(power applied/rated power) × 100%] is applied.

## Transient Response Standards

There are standards in various countries; and industries that require generator sets to be capable of accepting and recovering a full load step. However, many do not specify frequency and volt deviations. ISO 8528 has set transient response standards. Four performance classes are designated in ISO 8528-1-7 to describe a genset in terms of voltage and frequency. The chart below lists the performance class and their criteria and application examples. The performance class relevant for the application must be followed to be within the standard and achieve maximum performance.

|    |  |   |
|----|--|---|
| G1 | required for applications where the connected loads are such that only basic parameters of voltage & frequency need to be specified  | General purpose applications<br>Lighting & electrical loads |
| G2 | required for applications where the demand on voltage is very much the same as for the commercial power system. When load changes, temporary deviations in voltage and frequency are acceptable. | Lighting systems, pumps, fans and hoists                    |
| G3 | required for applications where the connected equipment may make severe demands on voltage and frequency and waveforms   | Telecommunications equipment                                |
| G4 | required for applications where the demands on voltage, frequency, and waveform are extremely severe   | Data-processing & Computer equipment                        |

Table 3 shows the acceptance (dip) and rejection (overshoot) parameters identified by ISO 8528-5. Class G4 is reserved for limits that are unique and must be agreed upon by the manufacturer and customer. ISO 8528-5 also sets limits on recovery times for each class and identifies how recovery time is measured.

|                           | Class G1 | Class G2 | Class G3 | Class G4 |
|---------------------------|----------|----------|----------|----------|
| Frequency<br>% Acceptance | -15      | -10      | -7       | AMC      |
| Frequency<br>% Rejection  | 18       | 12       | 10       | AMC      |
| Voltage<br>% Acceptance   | -25      | -20      | -15      | AMC      |
| Voltage<br>% Rejection    | 35       | 25       | 20       | AMC      |
| Time<br>Seconds           | 5        | 5        | 3        | AMC      |

Table 3. Class/Voltage Parameter  
AMC-Agreed between Manufacturer and Customer

SAE Standard J1349 specifies inlet air and fuel supply test conditions. It also gives a method for correcting observed power to reference conditions and a method for determining net full load engine power with a dynamometer to engines.

## BMEP

When sizing a genset, comparing engines may be necessary to determine optimal performance, especially when motor starting. Both torque and horsepower are necessary measures but are not helpful when comparing engines of different sizes and designs. Instead, engines can be compared by referring to their brake mean effective pressure.

The “mean effective pressure” is an average of the pressure that would need to be present in the engine’s cylinder for the power and torque to be produced. BMEP refers to the brake mep or the useful work done at the engine flywheel.

BMEP (Brake Mean Effective Pressure) is an indicator of how much engine torque is available. The BMEP can indicate if the pressure within the cylinder is within the optimal performance parameter. BMEP is a relative number that is only used as a standard to compare engines of different designs or sizes. It can be expressed in psi, kPa or bars.

### BMEP Load Step

Two engines of different sizes are working similarly if they operate at the same BMEP.

A BMEP load is described in the following diagrams and narrative.

### Step-by-Step Events — Load Applied

Figures 5 and 6 illustrate full load addition to a genset with a turbo-aftercooled engine, and a 1:1 Volt/Hz voltage regulator. Figure 5 shows how the parameters vary as a function of engine speed, and Figure 6 presents the same events versus time. It’s easiest to follow if you read the following text through once for each figure.

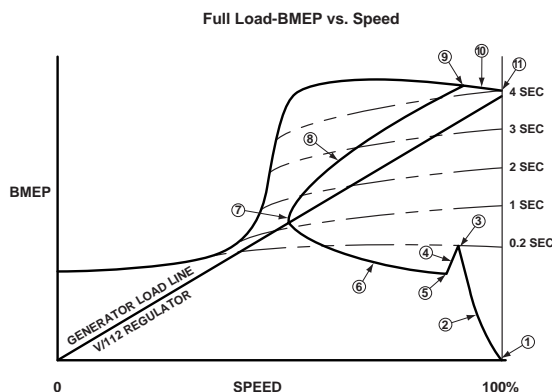

Figure 5.

1. Point 1 is the beginning of the event. The genset is stable at no-load, BMEP is zero, and speed is at high idle. Full load is applied instantaneously.
2. Speed falls and the governor increases fuel flow, increasing engine output BMEP. As speed error and time increase, the faster the governor increases BMEP.
3. At point 3, the engine reaches an equivalence ratio of 1.0, and power temporarily reaches a maximum. The time is so short that little turbo acceleration has yet occurred.
4. As the governor continues to increase fuel flow towards the rack stop, the additional fuel results in overfueling, smoke and loss of power.
5. At point 5, the governor reaches the rack stop and overfueling no longer increases.
6. The turbocharger accelerates, increasing air flow and engine power using some of the excess fuel. Since the turbo is so much slower than the governor, power increases much more slowly.
7. At point 7, engine output BMEP finally matches the load demanded by the generator. Since power and load are exactly equal, there is no acceleration or deceleration, and speed is constant for an instant at the maximum speed dip.
8. Since the speed error is still large, the rack is still wide open. Engine BMEP continues to increase, exceeding the BMEP demanded by the load. The excess BMEP permits the genset to accelerate, increasing speed towards rated. Power is still air limited.

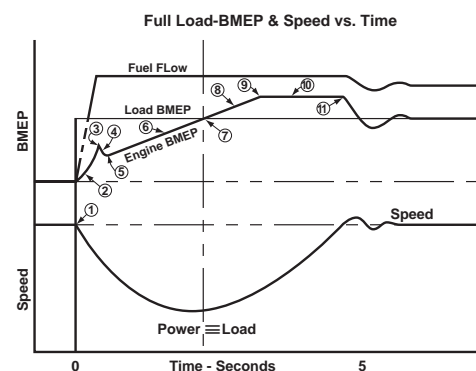

Figure 6.

9. At point 9, engine BMEP reaches its maximum level at the engine lug curve, although speed is still below rated. Power is now fuel limited.
10. The engine continues to accelerate, with BMEP limited by the rack stop, as the load line rises to meet it. Acceleration slows because the excess BMEP is decreasing.
11. Speed reaches rated, and the governor reduces fuel input until engine BMEP output exactly matches the load BMEP demand. Speed becomes constant again at the new load.

The engine can reach point 3 in about 0.2 seconds, since only governor action is required. With a TA engine, BMEP can reach roughly 140 psi without requiring turbo response. Thereafter, turbocharger acceleration will allow engine BMEP to increase by, say, 20-60 BMEP per second.\* Therefore, the example needs about 1.5 seconds to reach point 7, and about 4 seconds to reach point 9.

As engines of a given displacement are designed for higher and higher outputs, their capability to accept *block loads* does not increase. Although a turbocharged engine can produce more power than a similar displacement naturally aspirated engine, its capability to accept block loads does not necessarily increase. The ISO (International Standards Organization) has taken this into account in the following diagram from ISO 8528-5, the ISO Standard on Generator Sets.

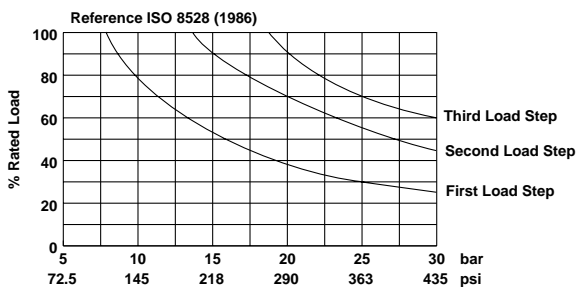

Figure 7.

\* Predicted turbo response is modified for engine underspeed error, overfueling, altitude, cold start and air impingement.

## Explanation of Figure 7

Using Figure 7, the number of load steps needed for desired power can be determined by first finding the BMEP of the engine at rated speed. (BMEP levels are shown for each rating on INFO CODE 01 of performance data in TMI.) If the percentage of block load is under the first load step curve, the block load can be accomplished in one step. If the percentage of the block load is greater than the first load step curve but smaller than the second load step curve, it will take two load steps to reach desired power. If the percentage of block load is greater than the first two load step curves but less than the third load step curve, it will take three load steps to reach desired power.

Caterpillar gensets are similar to class G2 of the ISO standard 8528-5. Class G2 gensets must accept any load on the curves and not deviate more than 12% of rated frequency, 25% of rated voltage and recover to rated limits within 5 seconds.

Load blocks and response to block loading is one of many considerations when sizing a generator set. Many turbocharged and aftercooled four-stroke diesel engines will not accept 100% block load in one step. Always investigate to ensure the selected generator set will, in fact, meet the application requirements.

## Engine Configuration

The way an engine is configured can effect the size of genset needed.

## Air System

The load acceptance behavior of an engine also depends on the type of air supply to the combustion system. Maximum engine power may be airflow restricted. Power can only be increased if airflow and fuel rate are increased. Engine airflow is determined by displacement of the engine, engine speed, and engine inlet air density. More dense air allows the generator set to perform more efficiently; thus a quicker response to varying loads.

For a given displacement, or given size of engine, more speed produces more airflow. The best way to increase airflow at speeds which are compatible with 60 Hz or 50 Hz is to increase the density of the air entering the cylinders. A turbocharger can increase pressure which will increase density. Density of the air can also be increased by cooling the hot, compressed air with a heat exchanger called an aftercooler. A separate water supply, jacketwater, or radiator airflow can be used for this cooling.

The configuration of the air systems can also have an effect on the transient response. A turbocharger equipped with a wastegate allows a larger turbocharger to be used but limits the turbo boost pressure under normal operating conditions. The engine runs faster and therefore increases airflow without overspeeding. Another example is the ability to decrease the transient response by increasing the number of turbochargers. This would allow the engine to run at the same BMEP but have a different transient response. Inlet air pressure in a turbocharger affects the air density as well. A smaller nozzle in the turbine housing of a turbocharger increases air velocity which causes the turbocharger to operate at a higher speed, thus, increasing boost and airflow. An engine equipped with watercooled exhaust manifolds will transfer less heat to the turbocharger, making it less efficient during short periods of acceleration.

## **Gas Engines**

Caterpillar Gas Engines are naturally aspirated (NA) or turbo-aftercooled (TA). Atmospheric conditions affect the way a NA engine can draw air into its system. A NA engine's load capability is directly affected by altitude and ambient temperature. TA engines have a turbocharger which compresses air which increases its temperature. A separate aftercooler is used so that air density and detonation margin are increased. TA engines can be derated so that they will not experience premature detonation.

## **Block Load and Transient Capability**

The block load capability or transient response of the gas engine genset package is less than its diesel engine counterpart. Most of this difference is directly attributed to the inherently different fuel systems of the two engines. When the governor calls for more power, a diesel engine reacts by adding fuel directly into the cylinder. This method permits the diesel engine to accept 100% block loads with acceptable voltage dips and frequency changes. When the governor on a gas engine calls for more power, the throttle opens and a larger flow of air/fuel mixture starts moving through the aftercooler core, air intake manifold, and then into the cylinder. This time delay detracts from the gas engines capability for accepting large block loads.

Considerable effort has been made to improve the transient electrical performance of the G3516B generator sets. The G3516B uses transient richening, a factory program to the control software to improve block load pick up. There is also a bypass line from the aftercooler to the inlet of the turbocharger which is equipped with an electronic valve. This system is called the turbo bypass which in conjunction with factory programmed software allows block unloads to be accomplished without turbo surge (rapid speed change of the turbocharger). With these 2 systems, the G3516B gensets are suitable for island operation. The G3516B gensets are able to accept transient load steps up to 50 % of rated power from no load, and 25 % from other load points. The gensets are able to reject transient load steps up to 25% of rated power from any given load point.

## **System Interaction**

The generator and voltage regulator are responsible for voltage deviation and recovery. The power produced by the generator is controlled by excitation of the rotor. The voltage regulator controls excitation (DC current).

Increased load draws more current from the generator, which causes the generator voltage to drop. As a response, the regulator increases rotating field excitation which increases its flux. This increase of flux brings the stator voltage back up. Thus, the generator can produce the higher current and power demand at the same voltage.

Maximum generator power is limited by temperature. Heat is produced in the winding by current flow. Magnetic flux changes also cause heat generation in the windings. Temperature can only reach certain parameters before it exceeds its design limit. Therefore, the easiest way to increase generator power is to make the generator bigger. More copper (windings) can carry more current without it raising the temperature. More iron (laminations) can handle more flux without increasing temperature.

The voltage dip or temperature rise is proportional to the generator size. When load is added, generator voltage drops as magnetic flux changes in the iron and airgap. A bigger generator has more iron so the flux deviation and voltage deviation from a given kW is less.

The sum of the time constants of the voltage regulator, exciter, main rotor, and main stator determine the voltage response and recovery. Typically this is less than one second, with additional time for the regulator to stabilize.

## Voltage Regulators

The voltage regulator is a key component in determining the amount of voltage/frequency deviation and recovery time. There are several different types of regulators:

- Constant
- Volts/Hertz
- 2 Volts/Hertz
- Digital Voltage Regulator (adjustable Volts/Hz)

A constant voltage regulator attempts to maintain rated voltage as the load is applied. Since the generator is maintaining rated voltage, it is maintaining applied load (ekW). We previously highlighted the relationship between ekW and bkW.

$$\text{bkW} = \text{Speed} \times \text{Torque}/\lambda$$

Therefore, when a constant voltage regulator is used, it imposes increasing torque on the engine during frequency dips. Since most genset engines are not designed for increasing torque, significant amounts of frequency dip can occur.

Engine speed rpm decreases as any load is imposed on a limited bus (generator). This causes frequency/voltage to dip accordingly. The greater the load, the greater the percent of dip and the longer it will take the engine to recover.

The “Volts per Hertz” (1:1 Volts/Hz) regulator was designed to impose a decreasing torque on the engine during frequency dips. The Volts/Hz schedules voltage proportionally to speed.

If the speed dips 15%, the Volts/Hz regulator will cause the voltage to dip by 15%. This will reduce current flow into the load by 15%. The kW absorbed by the load is then 0.85 (85% of volts) multiplied by 0.85 (85% of current), or 72.25% of rated power. The engine only has to produce 72.25% of rated hp. Mathematically, the formula for this concept is:

$$0.85 \text{ volts} \times 0.85 \text{ current} = 0.7225 \text{ power} = 0.85 \text{ speed} \times 0.85 \text{ torque}$$

Technology has advanced recently so that engine ratings have increased, increasing the possibility of more severe transient loading. In some cases a Volts/Hz regulator cannot prevent excessive frequency dip because of large load changes (the torque has increased so much the deceleration on load is extreme). Cat developed a 2 Volts/Hz regulator to address this need.

The 2 Volts/Hz regulator decreases voltage at twice the rate of dip. At 15% engine speed, the voltage would dip to 30% ( $2 \times 15\%$ ) and the load would be reduced to 70%. The kW absorbed by the load is then 0.7 (70% of volts) multiplied by 0.7 (70% of current) or 49% of rated hp.

If the genset is large enough to carry the running load the 2 Volts/Hz regulator may help in motor starting. A reduced motor starter may not be required with the 2 Volts/Hz regulator when starting large motors depending on system design and applied load steps. However, the entire connected system would have reduced voltage, not just the motor.

### Digital Voltage Regulator

The Digital Voltage Regulator is a microprocessor based voltage regulator. Its main purpose is to regulate output voltage of an engine generator set. It is designed to improve performance by allowing regulation characteristics to be modified that were previously not modifiable. This allows the engine generator set to function in a more efficient manner and to provide improved performance to the customer.

The Digital Voltage Regulator can be software configured to optimize the transient response of any Caterpillar generator set package by changing the underfrequency characteristics as well as the control loop gains. The microprocessor based design allows for unmatched flexibility in diverse applications.

## Customer Requirements

### Power Demand

#### On Site Power Requirement

Before selecting an engine model and rating, a load analysis needs to be performed. This section will consider the factors which affect generator sizing including load management needs, voltage and frequency dip limitations, motor starting considerations, start-up needs and all required standards.

### Load Management

Load management is the deliberate control of loads on a genset and/or utility so as to have the lowest possible electrical costs.

Assessing the customer's load profiles is a key component to establishing their load management profile and ultimately the size of genset needed to operate within that profile.

### Loads Profiles

The duration of a load must be established to select and operate a genset system at maximum efficiency. To analyze a load, a family of load profile charts are necessary. Chronological and duration load profiles best serve this purpose.

**Unless the load is known to be steady, this average can not be used to establish the engine and generator requirements because the average will always be lower than the maximum kW demand.**

The purpose of the monthly average number is to be able to graph a complete year and determine any seasonal variations.

A daily chronological load curve (Figure 8) shows load demand throughout the day. A chronological curve establishes peak daily demand and an energy usage profile which can aid in the selection of engine size. It is also useful in programming units for operating economically.

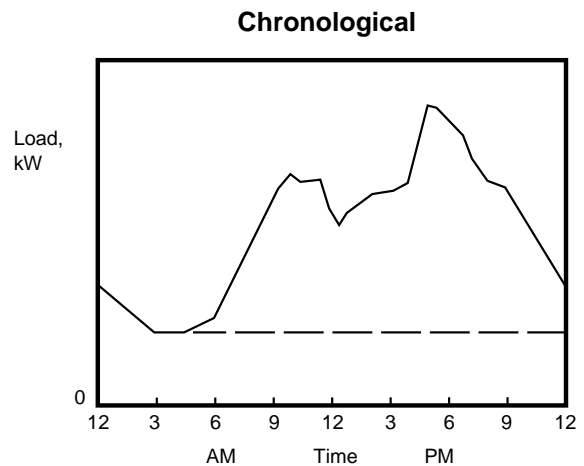

Figure 8.

Daily typical peaks (see Figure 9) for various industries can be graphed based on typical loads.

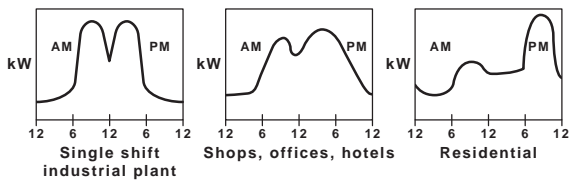

Figure 9.

Duration curves (see Figure 10) rearrange chronological curves and summarize daily load. Such curves are developed for a week, month, season, or year. The daily chart represents the average kilowatt load for each day, while the twelve month chart (see Figure 11) represents the average kilowatt load for each month.

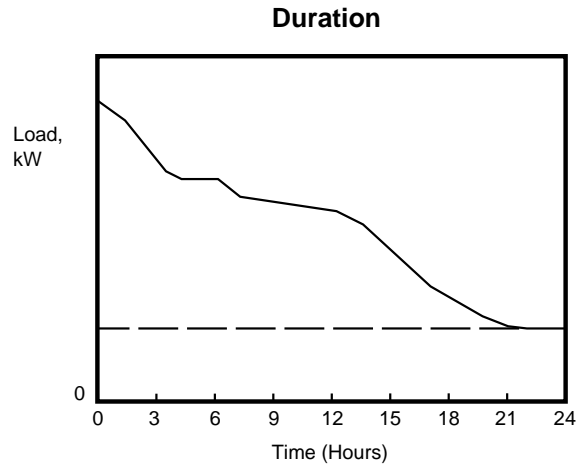

Figure 10.

For existing loads that are served by a utility, power bills or power consumption records will provide the needed data for a twelve month period. The average kW load can be determined by the following equation:

Avg. kW load for Month =

$$\frac{\text{Total kW used in month}}{\text{Total monthly hours of operation}}$$

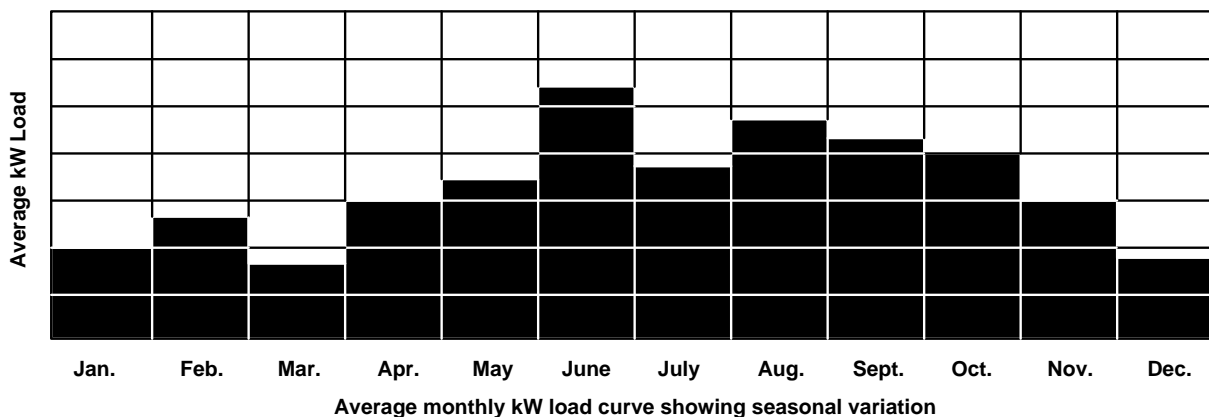

Figure 11.

## Estimating Load Data

Obviously, historical load data does not exist for a plant or facility not yet constructed. Table 4 estimates the average load of various facilities. While these numbers will have variations depending on site conditions, they are reliable and helpful in making preliminary feasibility studies for installation.

## Categorizing Loads

When developing a load estimate, it is helpful to categorize lighting and power loads. These loads are distinctly different.

Lighting loads are relatively constant. They are most often expressed as load density in volt-amperes (VA) per square foot (VA/FT<sup>2</sup>). In a commercial building, lighting loads typically range from 1.0 VA/FT<sup>2</sup> in a storage area to 15.0 VA/FT<sup>2</sup> or more in an office area.

Power loads involve loads other than lighting. Examples are motors, furnaces and rectifiers. Unlike lighting loads, power loads vary based on a variety of factors, including start and stop times, percentage of output and the associated power factor.

In addition to categorizing the loads, lighting and power loads are also estimated separately. The loads are later combined to determine the approximate total load.

| Load and Power Consumption Estimating Data    |  |                                       |
|---|--|---------------------------------------|
| Facility                                      | Power Usage  |                                       |
|   | Watts/sq ft  | kWh/ft <sup>2</sup> /yr               |
| Schools                                       | 4-5 average (43.06-53.82 W/m <sup>2</sup> (Total)) | 11 to 17                              |
| Class Rooms                                   | 5-6 (53.87-64.58)                                  | (1.02 to 1.58 kWh/m <sup>2</sup> /yr) |
| Locker Rooms, Auditoriums                     | 2-3 (21.53-32.29)                                  |                                       |
| Halls and Corridors                           | 20 Watts per running foot (65.62 W/m)              |                                       |
| Shopping Centers                              | 5 average (Total)                                  | 28 to 34 (2.6-3.2)                    |
| Stores, Large Department and Specialty Stores | 5-6 (53.87-64.58)                                  |                                       |
| Show Windows                                  | 500 Watts per running foot (1640.5 W/m)            |                                       |
| Office Buildings                              | 5-6 average  | 28 to 34 (2.6-3.2)                    |
| Private and General Offices                   | 4 (43.06)  |                                       |
| Professional Offices                          | 6-7 (64.58-75.35)                                  |                                       |
| Dentist, Drafting Rooms, etc.                 | 7 (75.35)  |                                       |
| Hotels and Motels                             | 3-4 average (32.29-43.06) (Total)                  | 12 to 17 (1.1-1.58)                   |
| Lounge  | 2 (21.53)  |                                       |
| Rooms   | 3 (32.29)  |                                       |
| Dining Rooms                                  | 4 (43.06)  |                                       |
| Exhibition Halls, Shops, Lobby, Kitchen       | 3 (32.29)  |                                       |
| Hospitals                                     | 1.5 to 2.5 kW per bed average                      | 8500 to 11400 kWh                     |
| Lobby, Wards, Cafeterias                      | 3 Watts/sq ft (32.29 W/m <sup>2</sup> )            | per bed per year                      |
| Private Rooms, Operating Rooms                | 5 Watts/sq ft (53.82 W/m <sup>2</sup> )            |                                       |
| Operating Tables                              | 3000 Watts each                                    |                                       |
| Major Surgeries                               | 1500 Watts each                                    |                                       |
| Minor Surgeries                               |  |                                       |
| Apartment Houses                              | 2-3 kW per unit (Total)                            | 11 to 17 (1.20 to 1.58)               |
| Lobby   | 2 Watts/sq ft (21.53 W/m <sup>2</sup> )            |                                       |
| Apartments                                    | 3 Watts/sq ft (32.29 W/m <sup>2</sup> )            |                                       |
| Small Appliances                              | 1.5 kW/unit  |                                       |

Table 4.

## VA/FT<sup>2</sup> Load Estimating

For estimating purposes, power loads and lighting loads can be measured in VA/FT<sup>2</sup>. However, a detailed analysis requires individual measurement of power loads to ensure accuracy.

A simple table (see Table 5) based on VA/FT<sup>2</sup> is used to obtain a rough estimate of a load as expressed in total kVA generated.

### Load Example

Calculate the load for a 10,000 square foot office with electrical air conditioning.

### Solution

From the left-hand column of the table, we know the maximum lighting load in an office building is 4.0 VA/FT<sup>2</sup> per square foot. Therefore,

$$4.0 \text{ VA/FT}^2 \times 10,000 \text{ (square feet)} = 40,000 \text{ VA needed to meet the lighting load.}$$

Following the table from left to right,

$$2.0 \text{ VA/FT}^2 \times 10,000 = 20,000 \text{ VA for miscellaneous power loads.}$$

$$7.0 \text{ A/FT}^2 \times 10,000 = 70,000 \text{ VA for electrical air conditioning loads}$$

Total the individual loads (40,000 + 20,000 + 70,000) to get a combined load of 130,000 VA.

A point to remember when using the table is that it does not account for power losses caused by the resistance found in wires and cables. A power loss of up to 6% would be factored into the VA total when estimating a facility with extensive wiring.

## Load Steps

Load steps refer to the amount of load that will be placed on a genset at one time. A genset may accept load in one load step, or may spread it out over several load steps. The customer can identify the needs of the environment and then a proper method of starting can be applied. (Recall BMEP load step analysis.)

Most loads do not draw power in a steady-state fashion. Therefore, it is important when selecting a generator to know the operating sequence and what else is running when loads are connected.

### Prioritization

Prioritization is the process by which the customer identifies what electrical loads are needed and in what priority. The highest priority loads would be in the first step; even if all the gensets are not ready for load. The first genset ready to accept load would take the first priority loads. The next step would go to the next highest prioritized load. This process will repeat until all loads are applied.

The smaller the steps, the smaller the transients — which means a smoother transition. For example, a medical center might prioritize lifesaving equipment as their number one need. That equipment (or special outlets for that equipment) would be the first supplied with electricity from the first available genset. Lights may be identified as the second most important need and handled by the second load step.

When starting generator sets without a preferred load order, it is suggested that the largest loads are started first. The largest transient will occur before the system is heavily loaded. These large loads will have the least effect on the rest of the system.

| Volt Amperes Per Square Foot (VA/FT <sup>2</sup> ) |                            |                        |                               |                                   |
|--|----------------------------|------------------------|-------------------------------|-----------------------------------|
| Facility Type                                      | Load Type                  |                        |                               |                                   |
|  | Lighting                   | Miscellaneous Power    | Air-Conditioning (Electrical) | Air-Conditioning (Non-Electrical) |
| Office Building                                    | 2.5-4.0 VA/FT <sup>2</sup> | 2.0 VA/FT <sup>2</sup> | 4.0-7.0 VA/FT <sup>2</sup>    | 1.5-3.2 VA/FT <sup>2</sup>        |
| Hospital   | 2-3 VA/FT <sup>2</sup>     | 1.0 VA/FT <sup>2</sup> | 5.7 VA/FT <sup>2</sup>        | 2.0-3.2 VA/FT <sup>2</sup>        |
| School   | 2.0-4.0 VA/FT <sup>2</sup> | 1.5 VA/FT <sup>2</sup> | 3.5-5.0 VA/FT <sup>2</sup>    | 1.5-2.2 VA/FT <sup>2</sup>        |

Table 5.

## Load Shedding

Load shedding refers to the method by which needs are prioritized after the gensets are started. During periods of high demand, some loads may be less important to the facility than others. These can be “shed”, or not powered, so that electricity can be given to the pre-determined essential loads. For example, in a factory, welding equipment and other machines may all be run at the same time at capacity between 10 am and 12 noon and then again between 1 pm and 3 pm. During these times the load to lights in the lunch room and parking lot would be shed because they would be less of a priority.

## Intermittent Starting

When loads include intermittent motor starting, such as furnaces or elevators which require power intermittently, all loads following the load where an intermittent load is connected must include the intermittent load as part of its total. This increases skVA requirements and a larger generator may be needed to account for these intermittent loads.

## Additional Load Categories

There are no official guidelines for categorizing loads. Architects, consultants, customers and contractors will determine categories for loads based on the project involved.

For example, loads on a project may be divided into lighting, heating and cooling loads. On another project, the loads may be categorized as normal, emergency and uninterruptable loads. The loads on a different project may be labeled as base, intermediate and peak shaving loads.

## Load Management Strategies

Power utilities sometimes offer their customers power discounts if their loads do not fluctuate or exceed a certain limit. The most common are peak shaving, base-loading and zero import/zero export control.

## Peak Shaving

Figure 12 shows how a utility customer can qualify for a discounted rate by not allowing the power demand to be above 500 kW. Any power generated over 500 kW is supplied by the customer’s generator. Thus, the customer “shaves” the peaks from the utilities responsibility. Peak shaving can be very demanding on an engine. It must be able to start quickly and automatically parallel to the utility. The response time of the engine is crucial because of the load fluctuations.

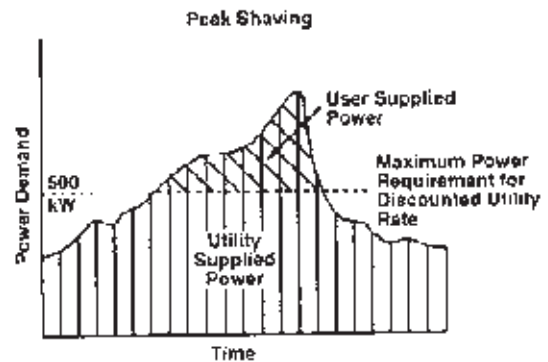

Figure 12.

## Base Loading

The least demanding power management type on an engine is base loading. The generator operates at a constant load and the utility imports power when the load exceeds the generator output. The user can also export power to the utility if the load is below the output of the generator. Figure 13 shows a base loading system and when power would be imported or exported. Since overloads are handled by the utility and the generator set is operating at a constant load, size and engine response time are not as crucial as in peak shaving.

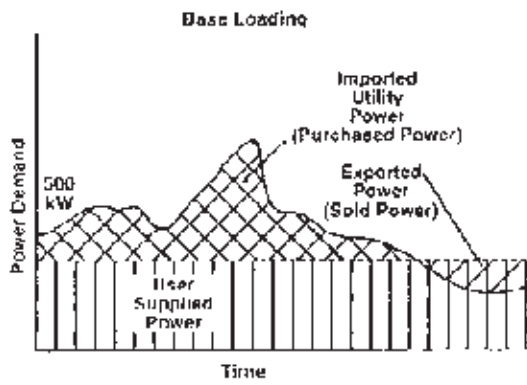

Figure 13.

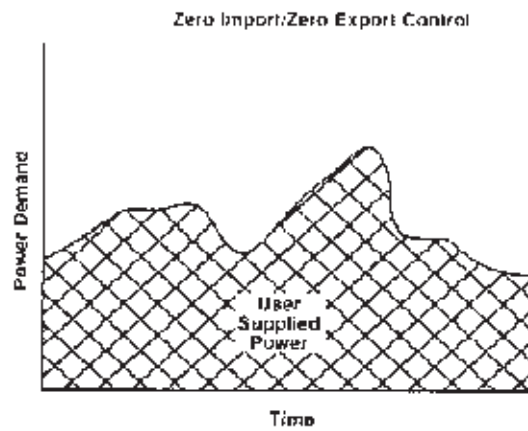

Figure 14.

### Zero Import/Zero Export

The load management type where the customer supplies all the electrical needs to the facility, while still paralleling with the utility is called Zero Import/Zero Export control (see Figure 14). If the power requirements fluctuate widely, a series of generator sets can be used and brought on-line as required. Since the customer remains paralleled to the utility, the demands made on the engines for this type are similar to base loading. Reliability is the chief concern for these customers. Utilities will often invoke demand charge penalties each time they are called upon to supply power.

### Peak Sharing

In a typical Peak Sharing arrangement, the customer installs and operates generators of specified capacity when directed to do so by the utility company. Under many peak sharing contracts utilities compensate the customer for each time they operate their onsite generators. The differences between Peak Shaving and Peak Sharing are outlined in Figure 15.

#### Concepts of Peak Shaving vs Peak Sharing

##### Peak Shaving

Customer sheds load or generates power to reduce own demand peak  
 Practice is generally discouraged by utility companies  
 Customer benefits at utility's expense in lost sales  
 Customer savings accrue from reduced demand charges  
 Concept is feasible only where customer experiences severe demand "spikes" and high demand charges  
 Customer decides when to run generators

##### Peak Sharing

Customer generates power to help utility reduce its peak  
 Practice encouraged by many utilities with generating capacity shortfalls  
 Because the utility benefits, it can afford to reward the customer  
 Savings accrue from interruptible rates or credits per kW of customer's on-site generating capacity  
 Concept is viable even for customers with relatively flat load profiles  
 Utility dictates operation when utility cannot meet all of its customers' demands

**If generators are installed for the sole purpose of taking advantage of peak-shaving incentives, the customer gains the additional benefit of acquiring backup protection against utility outages**

Figure 15.

## Co-generation

Co-generation is the term used to describe the load management system that produces electricity for lighting and equipment operations while at the same time it utilizes the waste heat produced in the exhaust for heating, cooling, or generation of process steam. Co-generation plants can operate independently of the utility or in parallel so the cogenerator can purchase from or sell power to the utility.

## Load Duration Curves

Load duration curves can also represent loads

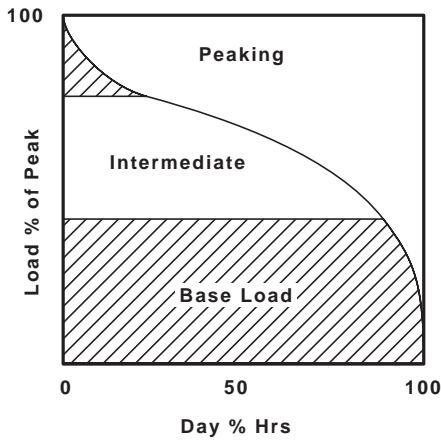

Figure 16.

In the example shown (see Figure 16), loads are arranged into descending order of magnitude based on the percentage of the total load. Generator sets powering the base load operate for the duration of a 24-hour period. Generator sets powering the intermediate load are activated for a limited period when the load increases to a specified level.

Generator sets earmarked to power the peak load are used to help power 100% of the load for a short period.

Knowing the type of load management that is most economical to a facility can help determine the size of genset needed based on the load factor and application.

## Estimating Rules of Thumb

Many rules of thumb can be used for estimating the varied types of loads. For example, in Table 6 the brake horsepower hour (BHP) of an air compressor rated at 125 pounds per square inch (PSI) can be found by multiplying the rated cubic feet per minute (CFM) of the compressor by 0.275. Fans, blowers, inclined conveyors, and welders can also be estimated using the information in this chart.

## Load Growth

The customers' future needs are to be taken into account when sizing the generator set. If the customer anticipates growth in their application due to increased volume or expanded needs, oversizing the engine or leaving room for another generator to be installed at a later date is reasonable and helpful to the customer. The projected load growth for any application should never be less than 10%. The table provided (see Table 7) shows typical load growth over a period of 10 years for various applications.

| Typical Load Sizing Rules of Thumb                            |  |   |                             |
|---|--|---|-----------------------------|
| Air Compressors   | Fans & Blowers   | Inclined Conveyors<br>(15° to 20°)  | Welders                     |
| 90 psi rating:<br>$0.225 \times \text{CFM} = \text{BHP}$      | $\text{BHP} = \frac{\text{CFM} \times \text{in. H}_2\text{O}}{6,346 \times \text{EFF.}}$ | $\text{BHP} = \frac{\text{Ft. Vertical lift} \times \text{Tons/Hr}}{500}$ | Light duty:<br>3 to 20 kW   |
| 100 psi rating:<br>$0.25 \times \text{CFM} = \text{BHP}$      |  |   | Heavy duty:<br>20 to 100 kW |
| 125 psi compressor:<br>$0.275 \times \text{CFM} = \text{BHP}$ |  |   |                             |

Table 6.

| Load Growth Over a Period of 10 Years |          |                |          |
|---------------------------------------|----------|----------------|----------|
| Bank                                  | 30 - 50% | Medical Center | 30 - 40% |
| Church                                | 10 - 30% | School         | 50 - 80% |
| Hospital                              | 40 - 80% | Warehouse      | 10 - 30% |

Table 7.

## Demand Factor

As mentioned, the load requirements must be defined as accurately as possible to best determine the size of genset needed. The “maximum demand” or “demand factor” is the highest demand which is placed on the supply within a specified period of time. After the total connected load has been found, it is important to know how much of the maximum load will actually be used at a given time. Another way to describe demand factor is the mathematical ratio of the maximum load divided by the connected load.

$$\frac{\text{Total Max. kW}}{\text{Total Connected kW}} \times 100 = \text{Demand Factor}$$

A line diagram can be used to further illustrate demand factor.

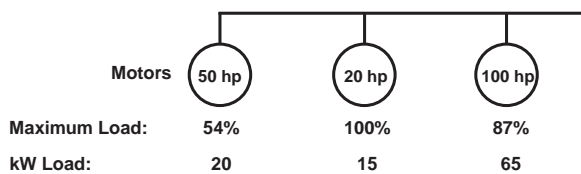

Figure 17.

On this system, three motors, rated at 50 hp, 20 hp and 100 hp each, are connected to a generator set. If the 50 hp motor is operated at 100% capacity, its total connected electrical load would be 37.3 kW. However, the 50 hp motor is only expected to produce 54% of its total capacity. Hence, the maximum electrical load is 20 kW. Operating at 100% capacity, the

maximum load of the 20 hp motor on the system is 15 kW, which is also the same as its connected load. The maximum load of the 100 hp motor, operating at 87% of its total capacity, is 65 kW.

### Example:

What is the demand factor of the system in the example shown?

### Solution:

To calculate the numerator add the individual kW loads

$$20 + 15 + 65 = 100 \text{ Max. kW Load}$$

For the denominator add the hp ratings for each motor

$$50 + 20 + 100 = 170 \text{ hp Total Connected Load}$$

The conversion factor for hp to kW is 0.7457 or 0.746. Therefore, total connected load is multiplied by 0.746 to get 126.82 kW, or 127 kW. ( $0.746 \times 170 = 126.82 = 127 \text{ kW}$ )

To find demand factor use the formula,

$$\frac{\text{Total Max. kW}}{\text{Total Connected Load}} \times 100 \text{ kW}$$

$$\frac{100 \text{ kW}}{127 \text{ kW}} \times 100 \text{ kW} = 79\%$$

Shown in Table 8 is a range of common demand factors.

| Range of Common Demand Factors  |                                    |
|---|------------------------------------|
| Apparatus   | Percentage of Total Connected Load |
| Motors for pumps, compressors, elevators, blowers, etc ...                  | 20 to 60 percent                   |
| Motors for semi-continuous operations, such as process plants and foundries | 50 to 80 percent                   |
| Arc welders   | 30 to 60 percent                   |
| Resistance welders  | 10 to 40 percent                   |
| Heaters, ovens, furnaces  | 80 to 100 percent                  |

Table 8.

## Diversity Factor

Diversity factor is the value placed on a small collection of loads. The value for the whole system itself, which is comprised of smaller

collections of loads, is called the diversity factor. Specifically, diversity factor is the mathematical ratio of a system's individual maximum demands divided by the maximum demand of the system as a whole. The equation used to calculate diversity factor is total maximum demands times 100 and divided by total incoming kW equals diversity factor.

$$\frac{\text{Total Max. Demand}}{\text{Total Incoming kW}} \times 100 = \text{Diversity Factor}$$

A one-line diagram can be used to further illustrate diversity factor.

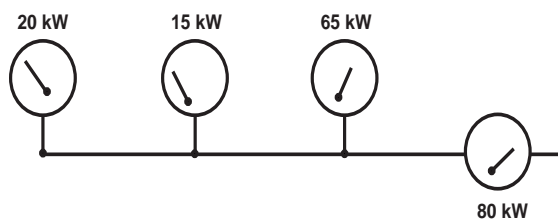

Figure 18.

It is important to know how much of the entire system's maximum load present at a given time. As shown in the diagram, (see Figure 18) individual loads are connected to load centers. The load centers have 20 kW, 15 kW 65 kW loads each for a total connected load of 100 kW. The 100 kW total connected load is routed to an 80 kW meter.

To determine the diversity factor of the system shown, 20 kW, 15 kW and 65 kW are combined to get a total connected load of 100 kW. To find the diversity factor use the formula to solve:

$$\frac{100 \text{ kW}}{80 \text{ kW}} \times 100 = 125\%$$

Typical diversity factors include:

- 1 Lighting feeders: 1.10 to 1.50%
- 2 Power & light feeders: 1.50 to 2.00% or higher.

## Demand Factor and Diversity Factor in Sizing

Demand and diversity factors are advantageous when sizing generator sets to the load.

However, the connected loads should be interlocked so that they cannot all be impressed upon the generator set at the same time. If the loads are not interlocked, the generator set rating could be exceeded. Despite this precaution, you must always assume that total time-current characteristics of all motors and other loads starting at the same time will not exceed the short-term generator set rating. The line diagram shown illustrates how demand and diversity factors are used in generator set sizing.

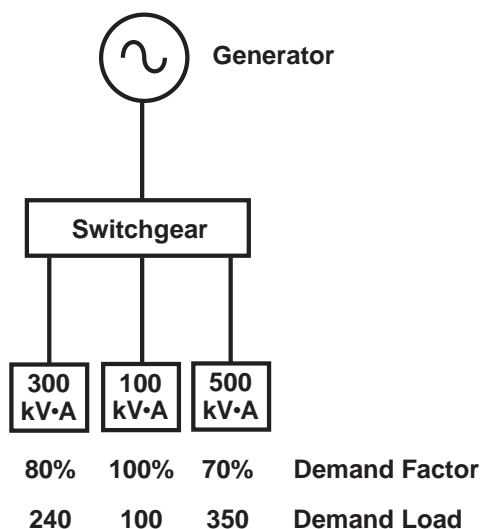

Figure 19.

In Figure 19, connected loads of 300 kVA, 100 kVA and 500 kVA are shown. After calculating demand factors for each of the same loads, the corresponding demand loads are 240, 100 and 350, respectively. When combined, the total demand load on the system is 690 kVA. When the diversity factor is 1.0, the total 690 kVA is divided by 1.0 to get 690 kVA. To meet this load, a generator set rated at 750 kVA is needed.

However, a different diversity factor on the same system will change the total kVA needed. If the diversity factor is 1.4, for example, 690 kVA divided by 1.4 equals 492 kVA. Hence, a generator set rated at 500 kVA would satisfy the load.

In summary, all loads need to be analyzed so that the correct size generator can be matched to the load. When sizing a generator for an application, the steady state load and maximum transient load need to be considered.

### Frequency Dips

Frequency dips are related to the size of load being connected. Twenty to 25% maximum frequency dip is the standard limit. A frequency dip above 35% **may** cause the engine difficulty in recovering. Frequency dips are normally more tightly controlled than voltage dips because they are typically connected to more sensitive electrical equipment.

### NFPA 110

The NFPA (National Fire Protection Association) standard 110 requires that a generator set must be capable of picking up a 100% block load. It **does not** specify frequency and volt deviations.

ISO 8528 also has transient response standards that are discussed in the Engine Ratings section of this chapter. The performance class relevant for the application must be followed to be within the standard and achieve maximum performance.

### Starting Requirements

The time it takes to initiate a genset startup and when it is ready to accept load is defined as its starting requirement. Starting requirements will vary depending on the application. A typical starting requirement is 10-30 seconds.

Load Acceptance is the point at which breaker closure is initiated. This is considered to be 90% of rated frequency. Figure 20 graphically shows a packaged genset's typical starting performance.

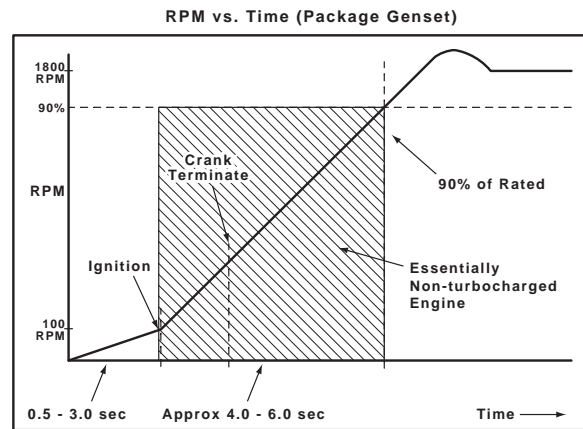

Figure 20.

Ten-second start refers to the ability of a generator set to start, accelerate to rated speed, and be ready to accept load within 10 seconds after receiving a signal to start.

For 10-second starting, the following conditions must exist:

1. Cranking batteries must be adequately sized and fully charged.  
\*Note: there is a difference for battery versus ambient temperature sizing. Also, in cases where air starting is used, the air system must supply the required air volume and maintain a 100 psi (689.5 kPa) minimum pressure.
2. Combustion air must be a minimum of 21°C (70°F).
3. A jacket water heater to maintain a minimum of 32°C (90°F) jacket water temperature.
4. A readily available supply of clean fuel.
5. The generator rotating inertia must not exceed that of the standard Caterpillar Generator.

Any variation in these conditions will affect the start time.

## **Natural Gas Engines**

Natural gas engines are capable of 10-second starting for some configurations. The same conditions for starting exist with natural gas engines as they do for diesel engines plus one additional condition. The solenoid gas valve must be located as closely as possible to the carburetor or “A” regulator, depending on the fuel train consists. A maximum distance of 0.61 m (2 ft) is desired.

A customer's starting time requirements should be determined before sizing the genset. If a customer requires a quick starting time, knowledge on how altitude, temperature, and other factors affect the engine starting time can help in finding the best solution.

## **NFPA 99**

The standard NFPA 99 is written specifically for health care facilities. 3-4.1.1.8 states “The generator set(s) shall have sufficient capacity to pick up the load and meet the minimum frequency and voltage stability requirements of the emergency system within 10 seconds after loss of normal power.”

Customers requiring this capability can achieve it by using the correct generator system. Size gensets according to this standard for all health care facilities in the United States.

Sizing a genset requires knowledge of the customer's loads and load management strategies as well as their requirements for transient response, emissions, and starting. All of these need to be determined before the genset size and rating are established.

## **Fuel Selection** (Also See the Fuel System Chapter)

Fuel selection can impact the performance of a genset and depending on availability, reduce electricity costs for a genset user. Natural gas, diesel and heavy fuels are common choices.

## **Natural Gas**

Natural Gas engines are appropriate for base loading, continuous operations. Natural gas does not respond well to transients so it would not be a good choice for loads with fluctuations. Natural gas can be less expensive, depending on availability, and it has superior emissions.

## **Diesel**

Diesel fuel is suited for large load fluctuations. Fuel normally recommended for diesel generator sets is No. 2 furnace oil or No. 2D diesel fuel. When this fuel is used for heating, common storage tanks for boilers and generator sets are practical. In addition to reducing installation costs, this arrangement reduces fuel costs by quantity purchases and minimizes fuel deterioration. Diesel is an excellent choice for base loading and standby applications

## **Heavy Fuels**

Heavy fuels are the by-products from the refining process of oil. It is extremely viscous and the fuel quality is low. However, it is very inexpensive. For industries which burn large amounts of fuel, heavy fuels are a choice to consider because of their economic advantages. Heavy fuels are not a good choice for standby applications.

## **Performance**

### **Emissions**

Standards on engine emissions are constantly evolving.

Special engine configurations allow operation with lower exhaust emissions. Gaseous exhaust emissions of diesel engines are the lowest of modern internal combustion engines. Engine emissions are measured using a Horiba or Beckman gas analyzer, with equipment and data measurement techniques conforming to U.S. Code of Federal Regulations, Title 40, Part 53 or 86.

Caterpillar has developed a correlation between smoke and particulate concentration which can be used to estimate particulate emissions.

**Black Smoke** is the soot portion of particulates and is caused by incomplete combustion. Black smoke is not considered an exhaust emission; rather it is a compilation of exhaust emissions with particulate matter being the largest contributor. Due to the fuel composition, gas engines typically do not have significant P.M. emission and therefore do not emit black smoke.

**White Smoke** is caused by vaporized, unburned fuel passing through the engine, and is also not considered a defined exhaust emission. White smoke typically will only be present during startup and will fade as the engine jacket water warms as the engine is loaded. Jacket water heaters help reduce White smoke at startup.

The sulfur present in the fuel oxidizes to form sulfur dioxide. The emission of sulfur dioxide depends on the amount of sulfur in the fuel and the fuel consumption of the engine. Sulfur dioxide emissions can be calculated using the following formula:

$$SO_2 = (00.01998) (BSFC) (\% \text{ sulfur in fuel})$$

SO<sub>2</sub> is emissions in g/kW-hr  
BSFC is Brake Specific Fuel Consumption  
% sulfur in fuel is a percentage by weight

Nitrogen Oxides are formed by the combustion air oxygen and nitrogen molecules combining. Nitric oxide gradually oxidizes to the more harmful, nitrogen dioxide in the atmosphere. Nitrogen dioxide is a poisonous gas which when combined with hydrocarbons in the form of sunlight create smog.

Nitrogen dioxide emissions in parts per million by volume can be approximated from the mass emission rate and exhaust flow:

$$NO_x \text{ concentration} = 629 \times \frac{NO_x \text{ mass emissions}}{(\text{exhaust mass flow})}$$

NO<sub>x</sub> concentration is in parts per million  
NO<sub>x</sub> mass emissions are in g/hr of equivalent NO<sub>2</sub>  
Exhaust flow is in kg/hr

Caterpillar offers standard (STD) engines for areas where emission levels allow. A catalytic converter can also be added for places where emission standards are more rigorous. Low emission (LE) engines are for areas where emissions are of primary concern. The LE engines use lean burn technology. Lean burn means that excess air is forced into the cylinder to cool the combustion process. This process reduces the NO<sub>x</sub> in the exhaust. LE engines can sustain higher loads without detonating. Because of this, LE engines have a higher rating than STD engines, given the same compression ratio and separate circuit aftercooler temperature.

Some measures that improve emissions levels will affect other areas for sizing considerations. Either kW are reduced or the response rate value may be higher in some instances. Of course this can affect engine ratings and the performance of the engine.

### Correction Factors

Emission levels are affected by the engine rating, speed, turbocharger, timing, fuel, and ambient conditions. Higher ambient temperature and higher altitudes increase nitrogen dioxide and particulate emissions. When engines are tested in the lab they are tested to specific standards outlined in ISO 8178-1 in regards to temperature, barometric pressure and fuel density. The nominal level of emissions data is derived under these conditions. The specific conditions can be accessed through TMI.

### Nominal vs. Not to Exceed

Engine emissions information is typically published in one of two formats. The first is nominal, which is what emissions levels would be expected from a nominal engine; while the second level is not to exceed, which is the maximum emissions output expected for an engine. It is important to understand these levels when comparing competitive information and when providing information to engineering consultants and end users.

“Not to Exceed” data includes a “Tolerance Factor” to account for paralleling and instrumentation and facility variations. If the “Not to Exceed” value is exceeded during field measurements, it is likely that the test equipment is at fault or that the engine has a problem.

Caterpillar engines at rated speed will not exceed:

| Emission g/bhp-h               | Diesel |      |      | Natural Gas         |              |
|--------------------------------|--------|------|------|---------------------|--------------|
|                                | NA     | TA   | T    | Catalytic Converter | Low Emission |
| Nitrogen Oxide NO <sub>x</sub> | 12.0   | 15.0 | 19.0 | 1.2                 | 2.0          |
| Carbon Monoxide (CO)           | 3.5    | 2.0  | 1.5  | 1.0                 | 1.7          |
| Hydrocarbons (NMHC)            | 0.4    | 1.5  | 1.5  | 0.5                 | 0.35         |

Table 9.

\*\*Depending on configuration and rating, many engines emit considerably less emissions. Specific emission data is available from the engine supplier.

## Heat Balance

Before a cooling system is designed, the designer must understand how much heat is being rejected through each of the cooling circuits. The following guide will help interpret and apply the heat rejection data.

Heat balance: The heat input into the engine equals the sum of the heat and work outputs.

Formula: Total Heat Input = Work Output + Total Exhaust Heat + Radiation + Jacket Water + Oil Cooler + Aftercooler.

In every calculation using engine data, there is a tolerance band or a deviation from norm. Heat balance tolerances must be applied when sizing cooling system components. The Caterpillar recommended tolerances vary depending on the engine mode and are published in TMI.

Additional information on this subject can be found in the Cooling System chapter.

## Use in Co-gen Operation

On a standard engine, the heat balance is not relevant to the customer in terms of performance. However, if the customer is looking to use co-generation it becomes crucial in their application. BTU's must be matched not just to the customers overall need, but their specific application need.

Many factors need to be taken into consideration if the customer needs 45% Btu's for heat and 45% for electricity (10% is lost) before determining the best solution. For example, should a genset be offered that is long on heat capability and short on electrical capability with the intent that the additional electricity needed be purchased from a utility? How about a genset that is long on electrical capability and short on heat? Will that option be better suited (ie. save the customer money) if a cooling system is used seasonally or year round? What are the prices for heating and electrical fuel from the utility? What type of load management options are available to them?

These are all questions that need to be determined with the customer's current and future needs in mind before recommending a solution to them.

## Load Analysis

Load analysis is the process of considering size, starting characteristics and intended usage of electrical loads and their collective impact on a generator set power source.

At times it may be necessary to conduct a detailed analysis, through discussion and observation, with the user, customer, or consulting/specifying engineer to determine the exact nature of the loads.

Determining the electrical load of a facility is the first and most important step in supplying a generator set. The generator set supplier is looked upon as the expert when it comes to choosing the right generator set to power the load. As a supplier of high-quality Caterpillar generator sets, it is important to understand electrical loads and possess a working knowledge of basic load analysis.

An electrical load is a device that uses electricity. Lights, motors, heaters, welders and communications equipment are just a few examples of electrical loads.

With electrical loads, it is important to understand the relationship between energy and power. Power is a rate of doing work. It is a product of force and motion. Electrical power is the product of electromotive force (volts) and current flow (amps). It is expressed in watts or kilowatts. Energy is work. It is the product of power and time.

$$(\text{Energy} = \text{Power} \times \text{Time})$$

In electric power generation, electrical energy produced or consumed is expressed in kilowatt-hours (kW-Hrs). A single kW-Hr of energy is one kW of electrical power used for one hour.

$$(\text{kW-Hrs} = \text{kW} \times \text{Hrs})$$

Loads have different electrical characteristics. When developing a load analysis, it is helpful to categorize loads into groups with common characteristics. There are no rigid standards for categorizing loads. Architects, consultants, customers and generator set suppliers will determine or speak of categories for loads based on the needs of the project involved.

For example, loads may be categorized as normal loads and emergency loads or perhaps critical loads and non-critical loads. There may be further division of the emergency or critical loads into additional categories of life-support or uninterruptible loads. On a different project the loads may be labeled as base, intermediate and peak shaving loads.

Load analysis should define those loads that are considered linear (draw current in a sine waveform) and non-linear (draw current in pulses or non-sine waveform).

Further definition of linear & non-linear loads are included in the Generator Set Selections Section.

Proper selection of a generator set as a power source frequently requires detail within these categories of linear or non-linear. In addition, loads can be separated as lighting loads, motor loads, and miscellaneous loads. A generator set is a limited power source, sometimes

referred to as a “limited bus”. The limited bus does not have the reserve capability of a utility grid. It is necessary to analyze and categorize generator set loads to assure proper consideration of their power demand characteristics.

The loads discussed in this chapter are going to be categorized by type and if they are linear or non-linear. Primarily we are going to separate the load as lighting loads, motor loads, and miscellaneous loads that have unique characteristics.

| Typical Electrical Loads   |
|--|
| <ul style="list-style-type: none"> <li>• <b>Lighting:</b> Incandescent lamps, fluorescent lamps, high-intensity discharge (HID) and arc.</li> </ul>        |
| <ul style="list-style-type: none"> <li>• <b>Heating:</b> Resistor ovens, convection ovens, dielectric heating, induction heating, arc furnaces.</li> </ul> |
| <ul style="list-style-type: none"> <li>• <b>Welding:</b> Resistance welding, arc welding, induction welding.</li> </ul>                                    |
| <ul style="list-style-type: none"> <li>• <b>Motors:</b> DC, induction, synchronous.</li> </ul>   |
| <ul style="list-style-type: none"> <li>• <b>Miscellaneous:</b> Rectifiers, solid-state controllers, communications.</li> </ul>                             |

Table 10.

## Lighting Loads

### Linear Lighting Loads

Linear loads are loads that draws current in a sinusoidal waveform (see Figure 21). There are many examples of linear loads, but lighting is the most common.

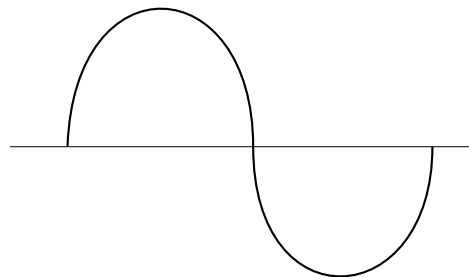

Figure 21.

## Lighting

Lighting loads are typically considered a constant load for sizing purposes; even though individual light circuits or lamp usage can be very diverse. Lighting is often expressed in volt-amperes (VA) or kilovolt-amperes (kVA) because it is primarily a resistive load with a near unity (1.0) power factor (pf). Therefore, if a lighting load is given in kVA, it is usually assumed to be of an equal kW value. There are several types of lighting.

### Incandescent Lighting

An incandescent lamp has a filament, which is heated to incandescence by an electric current. This is a very simple and commonplace electrical load. Incandescent lamps are rated by voltage and wattage requirements. The power factor is 1.0 so incandescent bulbs can operate on either alternating or direct current. These loads are often rated in watts. For example, ten 100-watt light bulbs would be a 1000 watt or 1 kW load. Current drawn by a lamp is found by dividing its wattage rating by a specified input voltage ( $A = W / V$ ). Incandescents draw high inrush currents and are suitable in applications which require flashing or dimming, with operation over wide voltage ranges. Any voltage fluctuation can affect the lamp brightness while extreme voltage fluctuations shorten filament life.

### Tungsten Inrush

Tungsten filament lamps are resistance devices. Resistance of tungsten increases rapidly with an increase in temperature. At room temperature, with the lamp "off", resistance is fairly low. However, the resistance element temperature increases rapidly when the lamp is turned on. Consequently, resistance increases as the lamp assumes normal operating temperature. Tungsten lamp inrush current can be up to 17 times greater than the normal current, but the surge lasts only a few cycles. Switches must be designed to handle such surges. This phenomena is not generally of consequence with a generator power source. However, very large blocks of tungsten lighting load may cause a momentary voltage dip transient of short duration to occur.

## Non-Linear Lighting Loads

Non-linear loads are AC loads where the current is not proportional to the voltage. Non-linear loads create harmonics, or additional sine waves that are a multiple of the generated frequency, in the current waveform (see Figure 22). Harmonics are discussed in detail in the Genset Selection Consideration Section.

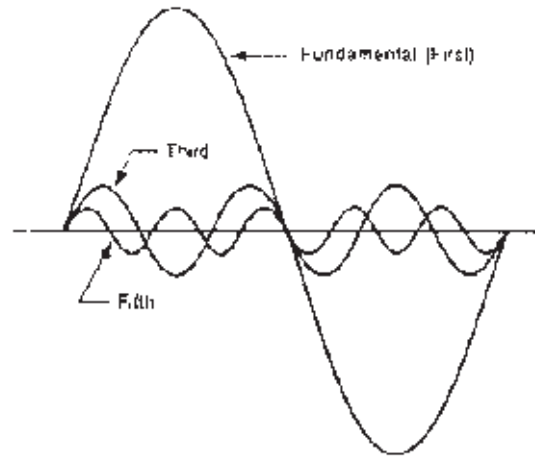

Figure 22.

### Fluorescent Lamps

Fluorescent lamps are also rated by voltage and wattage. Due to their ballast transformer, these lamps have slightly lower power factors (0.95 to 0.97). When incandescent or fluorescent type lights operate from stepdown transformers, power factor contribution of the transformer must be considered. Uncompensated fixtures can show power factors as low as 0.5 lagging.

### Gas Discharge Lamps

Gas discharge lamps are fluorescent, high pressure sodium or similar lamps which use a gas-filled chamber in combination with a low energy, high voltage sustained electric arc. Gas discharge lamps are rated by voltage and wattage.

There are two ways to obtain the required high voltage for a gas discharge light. One way is to use a ballast transformer. A ballast transformer, with saturating reactors, is used to provide proper voltage and control lamp current. The second technique is to use an electronic ballast. This type uses electronic power circuits to generate and control the lamp current.

The ballast current, due to the saturated reactor, is high in third harmonic content. Due to their ballast, these lamps have slightly lower power factors (0.95 to 0.97) than incandescent lamps.

Gas discharge lamps may be sensitive to transient voltage dip. Certain types of gas discharge lamps may extinguish during a severe transient voltage dip and delays in re-illumination may be experienced. Lamp manufacturers or suppliers should be contacted for characteristics. This is not typical of fluorescent lamps. As a general rule, avoid heavy SCR loads, large block switching loads, and large motor skVA loads on gas discharge lighting circuits.

## Motor Loads

In sizing a genset, it is important to identify the types of motors being used because of their starting characteristics. Starting characteristics may drive the need for a larger or smaller generator.

An on-site genset is a limited source of horsepower, from the engine, and kVA from the generator. Thus, a genset must be large enough to start as well as run connected motor loads.

Motors convert electrical energy into mechanical motion. They can present severe demands on the power source during starting and acceleration to rated speed. Current demand can range from five to ten times normal full load current during this period. That above normal current demand is called starting kVA (skVA). This often has great influence on generator selection.

Starting an electric motor can create voltage dips in excess of 40% if the genset is not properly sized. This can create serious effects on the existing loads such as dimming or extinguishment of lights or stoppage of motors due to insufficient voltage. Starting of motors will be discussed later in this section.

Pre-loads on motors do not vary maximum starting currents, but do determine time required for motors to achieve rated speed and current and to drop back to normal running value. If motors are excessively loaded, they may not start or may run at a reduced speed. Both starting and running current are considered when analyzing total kVA requirement.

AC electric motors represent inductive loads with lagging power factors between 0.5 and 0.95, depending on size, type, and loading.

With few exceptions, there are two basic types of AC motors: induction and synchronous motors.

## Induction Motors

Induction motors are the most common motor in use today. Induction motors have a stationary armature connected to the power source. The rotor winding, with rotating shaft, is excited by voltage induced from the magnetic field developed by the stationary armature windings. Voltage, induced in the rotor, results in current flow within the rotor winding. This current creates another magnetic field around the rotor conductors. Rotation of the rotor results from the interaction of rotor and armature magnetic fields as the armature magnetic field rotates around the stationary armature with the progression of AC current flowing in the armature windings.

There are two types of induction motors: Squirrel cage and Wound rotor.

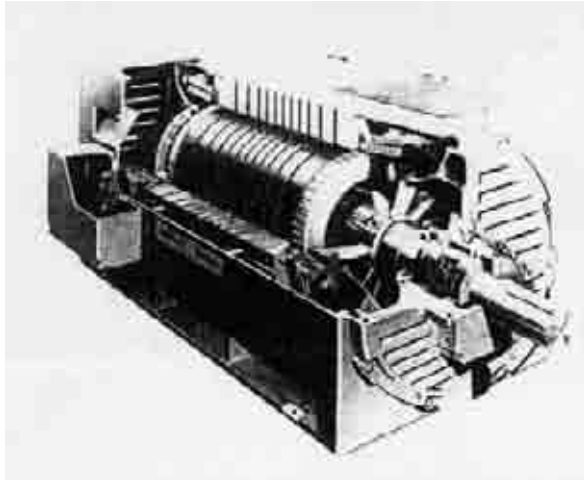

Induction Motor

### Squirrel Cage

The squirrel cage motor is the most widely used of all motors in industry. Most three-phase motors are squirrel cage type. When a constant speed drive with no continuous low-speed running is required, a squirrel cage motor is used.

The name is derived from construction of the rotor circuit. Solid conductor bars are arranged around the rotor periphery with their ends short-circuited. If this conductor assembly were removed from the steel core it would resemble the appearance of a circular small animal cage.

Squirrel cage induction motors are manufactured with design variants for specific performance features such as starting torque, speed/torque characteristic, and locked rotor amps. Squirrel cage motors are divided into four designs: A, B, C, D. Descriptions of these classes are discussed in the Motor Performance section. Table 11 lists the specifications for each class of motor.

| Squirrel Cage Motor Torques in Per Unit of Full-Load Torque |              |               |               |
|---|--------------|---------------|---------------|
| Class   | Locked-Rotor | Breakdown     | Pull-Up       |
| A   | 1.40         | Over 2.00     | 1.00          |
| B   | 1.40         | 2.00          | 1.00          |
| C   | 2.00         | 1.90          | Over 1.40     |
| D   | 2.75         | Not specified | Not specified |

Table 11.

### Wound Rotor (Slip Ring)

A wound rotor motor is a special induction motor whose rotor is wound with coils. Windings are placed in slots around the rotor periphery and connected to slip rings. The slip ring brushes are then connected to external resistors. Changing the rotor circuit resistance will change the induced rotor circuit current and vary the motor's speed/torque characteristics. High rotor resistance provides a high starting torque with low starting current. A wound rotor induction motor normally has five to seven steps of resistance in the rotor circuit.

Wound rotor motors are used for starting large rotating mass or high inertia loads with a long acceleration time. They provide a smooth start with minimized motor heating during the acceleration period. Usually the motors are started near unity (1.0) power factor. Starting current is limited to 130% of rated operating current. Because they have no code letter, exact operating performance must be obtained from the motor nameplate or manufacturer. Typical applications are large pumps, long conveyers, large diameter fans and large rotating drum devices.

Shown are current characteristics as they correspond to steps in resistance (see Figure 23). Also shown are percentages of total rated resistance in the rotor circuit. With 100% or maximum resistance when the motor is started at zero speed, the initial inrush line current is in the range of 100% full load current. If all rings were shorted at start up, as in a squirrel cage motor, there is zero resistance and starting current would be approximately 460% of full load current. This would present a much more severe starting condition. Normal operation is with all resistance shorted.

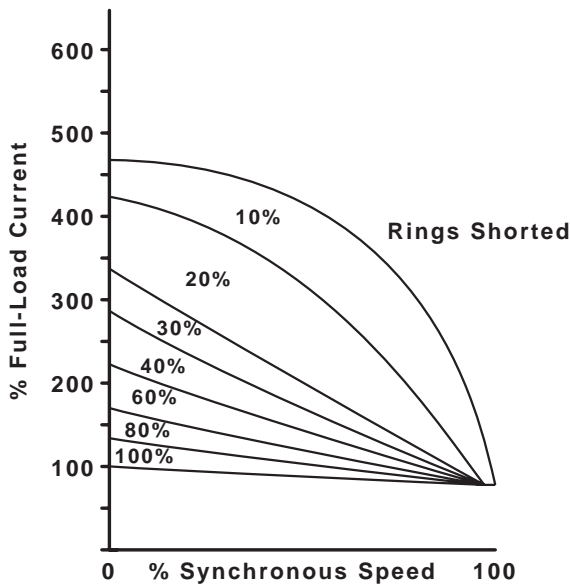

Figure 23. Wound rotor induction motor characteristics

### Slip Definition

Speed of an induction motor is almost constant from no-load to full load in relationship to the supply frequency. Ideally, if there were no resistance to rotor rotation, the rotor's magnetic field would follow exactly in synchronism with the armature's magnetic field. However, in induction motors, the armature's rotating magnetic field must cut through the rotor conductors to create the torque. In other words, an induction motor must run at less than synchronous speed in order to produce a driving torque. **Slip is a reduction of speed with increased load.** The amount of slip varies with motor design. A slip of approximately 3% at full-load is common with an induction motor.

Slip is the difference between the speed of the rotor and the speed of the stator rotating magnetic field. The equation used to calculate percentage of slip at full-load is:

$$\text{Slip at full load (\%)} = \frac{\text{Synchronous Speed} - \text{Full-Load Speed}}{\text{Synchronous Speed}}$$

Synchronous speed is established by the supply frequency and configuration of the stator winding into a number of magnetic poles.

In general, as the load of an induction motor increases, its speed decreases below synchronous speed.

**Example:** a six pole induction motor runs at almost 1200 r/min at no load and 1140 r/min at full-load when supplied with power from a 60 Hz 3-phase line.

What is the percent slip at full-load?

**Solution:** Slip at full-load (%) =

$$\frac{\text{Synchronous Speed} - \text{Full Load Speed}}{\text{Synchronous Speed}}$$

$$\text{Synchronous Speed} = \frac{120(f)}{\# \text{ poles}} = \frac{120(60)}{6} = 1200 \text{ rpm}$$

$$\frac{1200 - 1140}{1200} = 5\% \text{ slip}$$

### Synchronous Motors

Synchronous motors, like induction motors, demand large skVA when starting.

Synchronous motors are generally practical only in sizes above 40 horsepower where heavy loads are in constant operation. Synchronous motors maintain constant speed, synchronized with power line frequency.

Synchronous motors have two features that distinguish them from induction motors:

1. It runs at exactly synchronous speed.
2. The rotor is separately excited with DC while running at synchronous speed and this allows operating power factor to be varied.

Characteristics of synchronous motors vary from motor to motor. This variability makes it essential that performance characteristics be obtained from the motor manufacturer as this information may not appear on the nameplate.

## DC Motors

DC motors are used in applications requiring speed control, heavy load starting, or where other system elements require a DC power source. Full load efficiencies vary from 86%-92%.

DC motors have no power factor but, when driven through an SCR rectifier by an AC generator, the AC does have a power factor. To determine DC loads on an AC generator:

$$\text{DC amps} = \frac{\text{DC kW} \times 1000}{\text{DC volts}} \quad \text{AC amps} = \text{DC amps} \times 0.816$$

$$\text{AC kVA} = \frac{\text{AC volts} \times \text{AC amps} \times 1.732}{1000}$$

$$\text{POWER FACTOR} = \frac{\text{DC kW}}{\text{AC kVA}}$$

### Example:

Find the amount of single-phase power which can be safely drawn from a three-phase, 125/216 volt, four-wire generator set, rated to deliver 100 kW at 0.8 pf. The coil current rating of the generator set is 334 amperes. Assume the single-phase load is connected from one line-to-neutral and has an operating power factor of 0.9 lagging, and that the generator set is also supplying a three-phase load of 50 kW at a 0.8 pf.

### Solution:

1. Find the current drawn from each of the lines by the three-phase load.

$$P = \frac{3 V \times I \times \text{pf}}{1000}$$

$$I = \frac{P \times 1000}{3 V \times \text{pf}} = \frac{50 \times 1000}{1.73 \times 216 \times 0.8} = 167 \text{ amperes}$$

2. Find the coil current capacity remaining for the single-phase load.

$$334 - 167 = 167 \text{ amperes}$$

3. Find the single-phase power available.

$$P = \frac{V \times I \times \text{pf}}{1000} = \frac{125 \times 167 \times 0.9}{1000} = 18.8 \text{ kW}$$

When DC motors are at maximum rpm the system power factor is also maximized.

According to the application requirements, motors can be designed to provide various speed and torque characteristics. Modern day applications will almost always involve the use of packaged static component drive controls, commonly referred as SCR drives. SCR drives are discussed in detail later in this section.

A major consideration when sizing a generator is to look at the provision or inclusion of a suitable DC supply. There must be enough kVA to power both the DC supply and the load.

## Single-phase Motors

Single-phase motors are common in fractional horsepower sizes. They may occasionally be used in sizes as high as ten horsepower. Single-phase motors do not have the benefit of rotating magnetic fields produced by spaced voltage cycles of a three-phase circuit. Therefore, a separate starter winding is included in the stator with provisions to supply a magnetic field that is out of phase with the main stator winding field. This results in a rotating field to start things moving. A centrifugal switch disconnects the starter winding as it achieves rated speed.

Single-phase motors are not generally of great concern when started by a generator which is relatively larger in size. It is good practice to divide multiple single-phase motor loads into equal blocks per phase. If blocks of single-phase motors are spread equally over the three-phases and started as a group, this motor load can be considered as a single three-phase motor of equal hp. The skVA may be higher because the skVA per hp is typically higher for single-phase motors. The total kW load may also be somewhat higher because small motors are frequently less efficient than large motors.

If the single-phase motor load cannot be distributed, it may be necessary to verify the ability of the generator to provide the skVA. Generally, with large blocks of single-phase motors started from one phase, the available skVA of the generator will be 56% of the normal three-phase skVA.

### Three-Phase Motors

Three-phase motors are very common in industry. They provide more output for physical size than single-phase motors and have the advantage of having a simple designed rotating magnetic field that turns the rotor for starting. In a three-phase motor, there are three equally spaced voltage cycles feeding respective windings in the stator. A rotating magnetic field is produced which the rotor immediately begins to follow. Therefore, no special starter winding is required to begin rotation.

### Motor Performance

Most three-phase motors are squirrel cage type as mentioned earlier. When rotor slot cross sections are changed, different torque and speed characteristics result. How a motor and its load impact a generator is highly dependent on the characteristics of the motor.

### Design Class

Motors with various rotor designs are classified in the U.S. by the National Electrical Manufacturers Association (NEMA) as Design A, B, C or D.

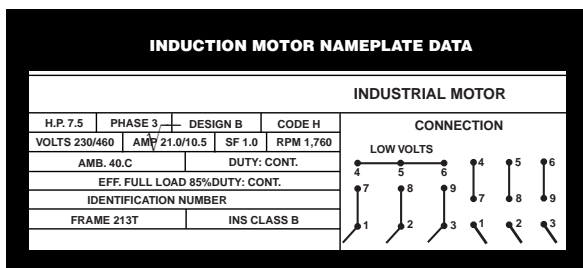

Figure 24.

In the following design descriptions, *slip* applies to the difference between motor full load speed and its synchronous speed\*. For example, a four pole 60 Hz motor has a synchronous speed of 1200 rpm, actual full load speed might be 1164 rpm, in which case the slip would be 3%. Each motor design has its own unique characteristics.

**Design A** — These motors are quite comparable to Design B motors, having normal torque, slip, and starting current. The most significant difference is that starting currents are limited by NEMA for Design B and not for Design A.

Design “A” motors have low rotor resistance and operate with small slip at full load. Their disadvantage is their low starting torque and high starting current. Because they achieve full speed rapidly and do not overheat during starting, these machines are suitable for applications in which they are required to start with very low load torque.

**Design B** — This motor is overwhelmingly the general purpose motor of industry. Its combination of low starting current and normal torque and slip makes it an excellent choice for driving many types of industrial loads.

Design “B” motors run at a slip of less than 0.05 at full load with larger machines running a very efficient 0.005. These motors are applicable for systems requiring low or medium torque.

**Design C** — Design C motors have high starting torque, low starting current, and low slip. The high breakaway torque makes the Design C a good choice for hard-to-start loads.

Design “C” motors are designed to start at full load torque and also run at slips of less than 0.05 at full load. Class “C” motors have higher starting torque per ampere of starting current than class “B” motors.

**Design D** — These motors have very high starting torque, high slip and relatively low starting current. Design D permits high breakaway torque and high running horsepower to be concentrated in a relatively small frame size.

Design “D” motors are applicable when “soft” speed is required. Intermittent drives requiring high acceleration under high-impact loads would use a Class D motor. The breakdown torque of a Class D motor runs at a slip of 0.5 or higher. This makes a Class D motor very inefficient. Also, to keep the starting current low, rotor bars of high heat resistant material are used. The losses of the rotor circuit necessitate building a large and therefore expensive machine for the given power. This strategy has to be weighed against the advantage of the soft speed characteristic which is needed in some applications to determine if a Class D motor should be used.

Characteristics of each design are shown on the speed and torque characteristic curves, as shown.

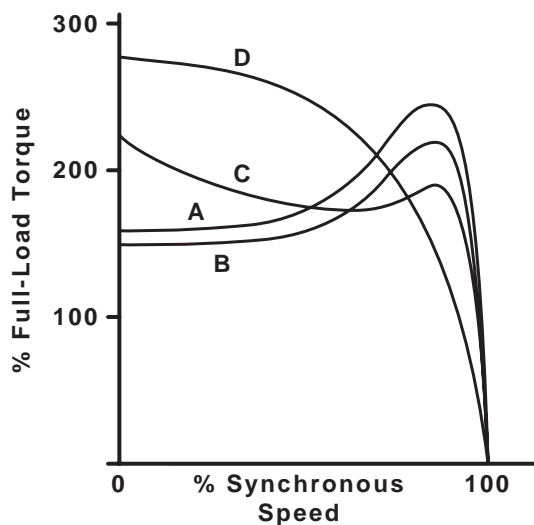

Figure 25.

\* A variation of the induction motor, known as the synchronous reluctance motor, is available for applications such as synchronized conveyor systems. These motors run without slip at exactly synchronous speed, regardless of load, but should not be confused with true synchronous motors. Power factor is not adjustable and is, in fact, poorer than for standard induction motors, locked rotor and full load currents are also higher than for standard squirrel cage motors. Modern synchronous reluctance motors require no external source of de-excitation. They are offered in numerous versions, including gearmotor styles.

Table 12 presents general guidelines for selecting a motor of the proper NEMA design letter.

| Desired or Required Conditions  | Typical Applications  | Recommended NEMA Design Letter |
|---|---|--------------------------------|
| Load requires only normal starting torque; continuous duty capability with ability to handle minor temporary overloads                              | Centrifugal pumps and compressors, reciprocating compressors started unloaded, fans with normal inertia, palletizers, conveyors, lathes, milling machines, saws, grinders, sanders, drill presses | B or A                         |
| Hard-to-start loads in continuous or intermittent service; some overload capability required  | Reciprocating compressors started loaded, conveyors started under heavy load, Banbury mixers, crushers without flywheels, hammer and ball mills, high-inertia fans                                | C                              |
| High breakaway torque required; intermittent or reversing/plugging service; high-inertia loads with long acceleration time; heavy fluctuating loads | Cranes, hoists, elevators, crushers and punch presses with flywheels, large-diameter fans, reversing-type machine tools   | D                              |

Table 12.

Of these characteristics, torque is most important to the original designer in selection of a motor for a specific application. The design class of a motor is not normally considered when sizing a genset because of the greater importance of the starting kVA requirement. Starting kVA usually dictates the size and selection of a generator set which will provide more than adequate power for the motor to produce the required starting torque. However, the use of oversized generators, reduced voltage motor starting and heavily loaded motors may require special consideration.

### Motor Starting

Induction motors have typical starting characteristics. When a motor is started, it draws approximately six times its full load current. This current remains high until the motor reaches about 80% of speed. This high inrush of current causes a voltage dip in the generator. A motor produces mechanical torque that is proportional to the applied voltage. In cases where generator voltage

dips below rated voltage, the motor is producing less than proportional torque.

The initial voltage dip associated with motor starting is primarily a function of the generator magnetic circuit. Use of a permanent magnet excitor or other excitation support systems will assist in preventing total excitation collapse in extreme voltage dip cases. It is important for the generator to restore voltage after initial voltage dip to accelerate the motor to rated speed. The degree of motor loading affects recovery time.

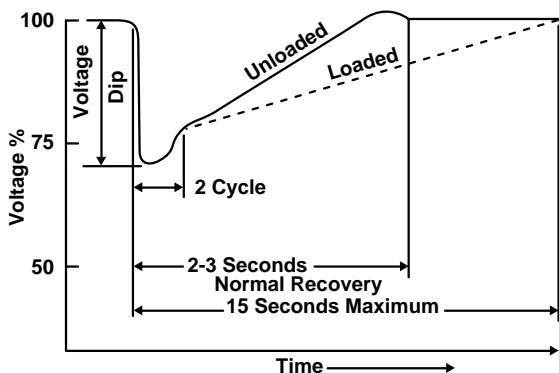

Figure 26.

Although unloaded motors impose high inrush current (skVA) in generators while starting, kW load on the engine is usually small. However, motors can draw more than rated kW during starting and acceleration to rated speed. Motors connected directly to high inertia centrifugal devices or loaded reciprocating compressors cause severe frequency excursions and lengthy motor run up. Comparing starting currents between loaded and unloaded motors shows the extended time loaded motors demand high current (see Figure 26). The effect of loaded motors on both engine and generator must be determined, particularly if large motors have high inertia loads and increase load during acceleration (for example, large centrifugal fans and pumps).

| Effect of Voltage on Loads — General Purpose Motors |                      |                      |                    |                    |
|---|----------------------|----------------------|--------------------|--------------------|
|   | 100% Volts           | 90% Volts            | 105% Frequency     | 95% Frequency      |
| Torque  | Increased 21%        | Decreased 19%        | Decreased 10%      | Increased 11%      |
| Synchronous Speed                                   | No change.           | No change.           | Increased 5%       | Decreased 5%       |
| Full-Load Speed                                     | Increased 1%         | Decreased 1.5%       | Increased 5%       | Decreased 5%       |
| % Slip  | Decreased            | Increased            | Slightly increased | Slightly decreased |
| Power Factor  | Decreased            | Increased            | Slightly increased | Slightly decreased |
| Starting Current                                    | Increased 10% to 12% | Decreased 10% to 12% | Decreased 5% to 6% | Increased 5% to 6% |
| Full-Load Current                                   | Decreased 7%         | Increased 11%        | Slightly decreased | Slightly increased |

Table 13.

An accurately sized genset will support the high starting kVA (skVA) requirements of the motor and supply sufficient output voltage for the motor so it can develop adequate load to rated speed. The generator set must have sufficient starting kVA capacity to limit momentary voltage drop. A 30% voltage dip is generally acceptable, depending on equipment already on-line. Motor starting capability data is available on spec. sheets and TMI for all Caterpillar generator sets.

U.S. motors are identified by National Electric Manufacturers Association (NEMA) with a code letter on the nameplate to identify the starting characteristics (see Table 14). The code letter identifies the starting kVA per hp. Table 15 can serve as a guideline for motors outside the U.S.

| Identifying Code Letters on AC Motors |                   |
|---------------------------------------|-------------------|
| NEMA Code Letter                      | Starting kVA/A/hp |
| A                                     | 0.00-3.14         |
| B                                     | 3.15-3.54         |
| C                                     | 3.55-3.99         |
| D                                     | 4.00-4.49         |
| E                                     | 4.50-4.99         |
| F                                     | 5.00-5.59         |
| G                                     | 5.60-6.29         |
| H                                     | 6.30-7.09         |
| J                                     | 7.10-7.99         |
| K                                     | 8.00-8.99         |
| L                                     | 9.00-9.99         |
| M                                     | 10.00-11.19       |
| N                                     | 11.20-12.49       |
| P                                     | 12.50-13.99       |
| R                                     | 14.00-15.99       |
| S                                     | 16.00-17.99       |
| T                                     | 18.00-19.99       |
| U                                     | 20.00-22.39       |
| V                                     | 22.40 -           |

Table 14. U.S. Motors

The following chart (see Table 15) lists standard sizes for 50 Hz motors. The starting kVA numbers should be used as a guideline only. For exact skVA of a motor consult the motor manufacturer.

| Motor Size kW | Starting kVA |
|---------------|--------------|
| .37           | N/A          |
| .55           | 4.9          |
| .75           | 6.9          |
| 1.1           | 9.5          |
| 1.5           | 13.4         |
| 2.2           | 19.8         |
| 3             | 29.7         |
| 4             | 41.4         |
| 5.5           | 53.8         |
| 7.5           | 73.1         |
| 11            | 103          |
| 15            | 143          |
| 18.5          | 171          |
| 22            | 204          |
| 30            | 254          |
| 37            | 322          |
| 45            | 378          |
| 55            | 502          |
| 75            | 721          |
| 90            | 906          |
| 110           | 1049         |
| 132           | 1255         |
| 160           | 1557         |
| 200           | 1940         |
| 250           | 2476         |
| 315           | 3113         |
| 356           | 3421         |

Table 15. Non U.S. Motors

The rated hp as well as starting kVA must be known to properly evaluate the impact starting a motor will have upon a specific system. When sizing a genset, the acceptable level of motor torque for starting must be determined or the loads will accelerate slowly or even fail to reach full speed.

### Starting Power Factor

Generator sets are typically evaluated on the basis of their ability to start electric motors and accelerate to full speed. Regardless of whether the motor has load or not, starting it requires kVA far in excess of the motor's normal running kVA demand. Generator heating is produced by the current which is why generators are rated for maximum kVA and not maximum kW. The **ratio of kW/kVA is the power factor**. Motors exhibit low power

factors when starting. Normal industrial loads have a power factor of 0.8. This is the value used for NEMA standard and Caterpillar ratings.

Load imposed on the engine during a motor start is calculated by:

$$kW = \text{Starting kVA} \times \text{pf}$$

Shown is the approximate starting power factor of squirrel cage motors.

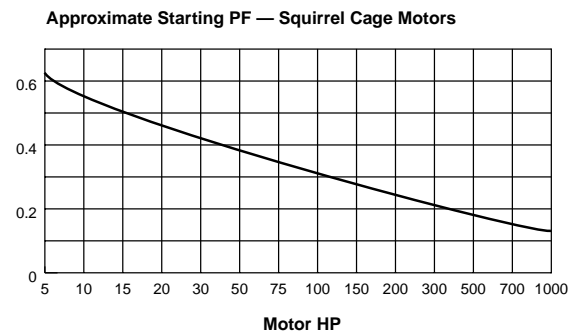

Figure 27.

As shown, a 5 hp squirrel cage motor has a lagging power factor of approximately 0.6 pf while a 200 hp squirrel cage motor has a lagging power factor of approximately 0.25 pf.

The chart can be used to help determine the total kW needed when a squirrel cage motor, or group of motors, is started.

### Example:

How much kW is needed when a Code G 200 hp squirrel cage motor at 6.0 kVA per hp is started?

### Solution:

$$\begin{aligned} \text{skVA} &= \text{kVA}/\text{hp} \times \text{hp} \\ 6.0 \times 200 \text{ hp} &= 1,200. \end{aligned}$$

Using the chart to find the lagging power factor of a 200 hp squirrel cage motor, you find it to be = 0.25 pf.

$$\begin{aligned} \text{skVA} \times \text{pf} &= \text{kW} \\ 1,200 \text{ skVA} \times 0.25 &= 300 \text{ kW}. \end{aligned}$$

The chart can also be used to compare how much kW is required for one motor versus a group of motors.

**Example:**

How much power is needed when ten Code G squirrel cage motors rated at 20 hp each are started? Which requires more power — ten 20 hp motors, or one 200 hp motor? The motors are rated at 6.0 kVA per hp each.

**Solution:**

First, find total horsepower by multiplying 10 by 20 to get 200.

$$skVA = kVA/hp \times hp$$

$$6.0 \text{ kVA} \times 200 \text{ hp} = 1,200 \text{ skVA}$$

Next, use the chart to find that the lagging power factor for a 20 hp motor is approximately 0.46 pf.

$$skVA \times pf = kW$$

$$1,200 \times 0.46 = 552 \text{ kW.}$$

It was found earlier that a 200 hp motor required 300 kW.

Therefore, ten 20 hp squirrel cage motors require 84 percent more kW than the 200 hp squirrel cage motor during starting. (300 kW vs. 552 kW)

**Motor Starting Load**

The nameplate of a motor gives some important information in regards to sizing.

The Motor Starting Codes identify the starting kVA (skVA) per hp. If the nameplate does not list the motor starting code, it is likely to list the Locked Rotor Amps. The Locked Rotor Amp (LRA) is a measurement of the initial inrush of current when a motor is started.

Motors, either loaded or unloaded, draw several times rated full load current when starting. Satisfying this inrush, places a large momentary kVA demand on the generator called the starting kVA (skVA). SkVA can be calculated from locked rotor current.

$$skVA = (V \times A \times 1.732) / 1000$$

Motors generally exhibit low power factors (0.2 to 0.5) when starting. Load imposed on the engine during starting is calculated by:

$$kW = \text{Starting kVA} \times pf$$

**Example:**

By using the following equation and the NEMA Code Chart one can find skVA/hp.

$$skVA = (skVA/hp) \times hp.$$

**Motor Torque**

Motor torque is required to accelerate and drive the load. Torque is a turning force. It defines the ability of the motor to twist the motor shaft.

Motor loads are established to determine if generator and engine have, respectively, adequate kVA and kW. Motor load is defined as the torque required by load. This torque, in lb-ft (N•m), is usually related to speed. Motor load, in horsepower equals:

$$hp = (lb\text{-ft} \times rpm) / 5250 \text{ or } (N\cdot m \times rpm) / 7350$$

The following torque requirements must be established (usually expressed as percent of running torque): Breakaway torque, accelerating torque, synchronous torque and peak torque.

**Starting (Breakaway) Torque**

Starting torque is the maximum torque required to start rotation. Stated differently, it is the torque required to initially breakaway or overcome friction to start the load from a standstill. Shown is the relationship between starting current and torque (see Figure 28). The starting current starts at the locked-rotor value as determined by the NEMA code or locked rotor amps on the nameplate. The current then drops to its rated value as speed and torque approaches normal.

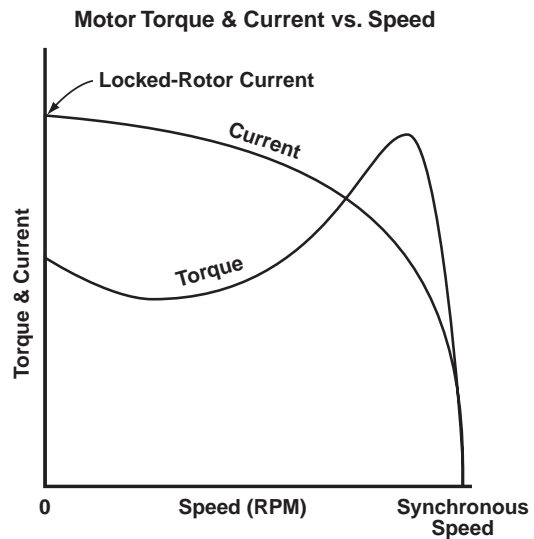

Figure 28.

Breakaway torque depends on the load's static resistance to rotation. The load's static friction can be higher than the rolling friction depending on the characteristics of the driven device. The load breakaway torque must be less than motor locked rotor torque or the load cannot be started. Shown are types of torque and the names used for each. Also shown is a typical load torque curve.

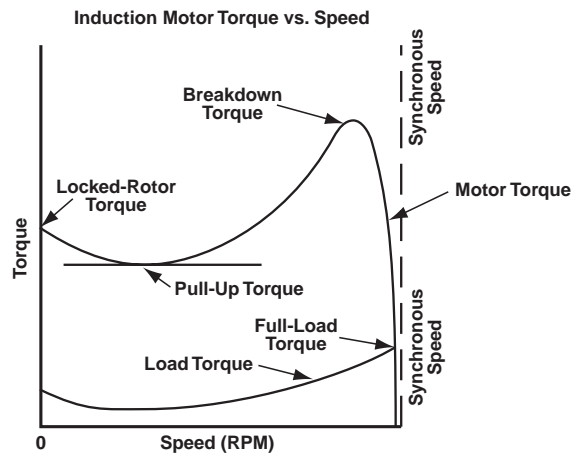

Figure 29.

- Breakaway torque: The torque required to initially breakaway or overcome friction to start the load from a standstill. The load breakaway torque must be less than motor locked rotor torque or the load cannot be started.

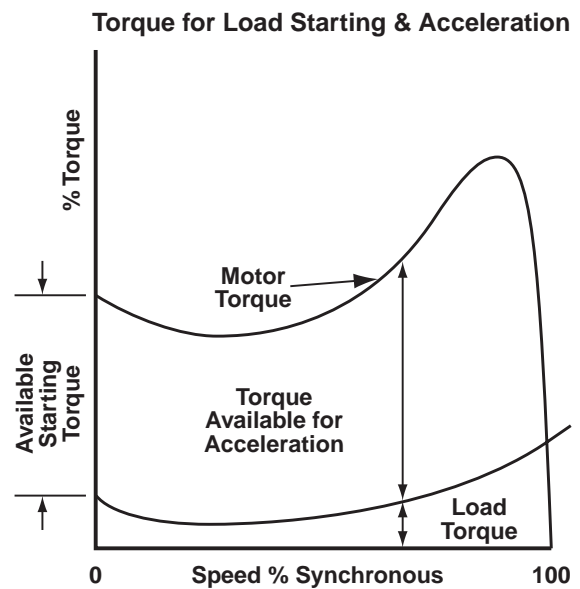

Figure 30.

- Locked-rotor torque (also known as Starting Torque): The torque a motor exerts at zero speed. This torque is important because it is the torque that is required to start movement of the load.
- Pull-up torque: The minimum torque produced between zero and rated speed. In most cases, this is equal to the locked rotor torque but in some motors may be less than the starting torque.
- Breakdown torque: The maximum torque exerted between zero and rated speed. This point is often the highest generator load point and must be considered when sizing large motors.
- Full-load torque: The torque capability of the motor at rated load and speed. Note, that speed is less than synchronous speed. This is due to the slip required to produce torque. If the actual running torque demanded by the load is less than rated full load torque of the motor, running speed will more nearly approach synchronous speed.

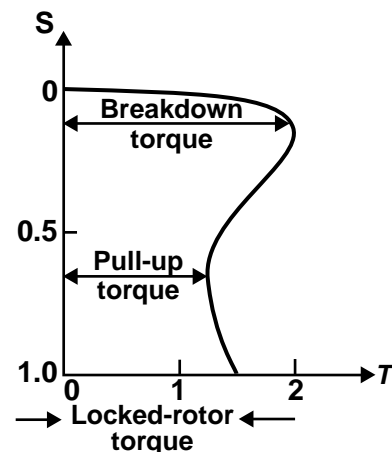

Figure 31. Speed torque curves of typical squirrel cage motors

The Figure 31 represents speed torque curves of typical squirrel cage motors.

## Acceleration Torque

Acceleration torque is the net difference at any speed between load required torque and motor available torque. Minimum motor torque must exceed maximum torque demanded by connected load. The time necessary to achieve full rated speed is of utmost importance. Small accelerating torque is usually caused by reduced voltage at the motor.

Prolonged accelerating time with high current draw will reduce useful motor life. Figure 32 reflects typical motor capabilities.

## Acceleration Time

The difference between the torque developed by the motor and the torque required by the load will determine the rate of acceleration or acceleration time (see Figure 31). If the load torque exceeds the motor torque at any point, the motor will stall.

Considerable heat can be developed within the motor during start-up, especially in the rotor. The motor can be damaged from excessive heat if the starting time is excessive or exceeds that intended by the motor manufacturer.

There is no precise answer for the amount of time allowed to avoid motor damage during load acceleration. However, motor manufacturers provide general guidelines. Typically, 8 to 15 seconds or greater is a concern. Some motors are protected with thermal overload relays to trip off before this becomes a problem. The number of starts and time interval between starts as well as the frame size are all considerations to be taken into account.

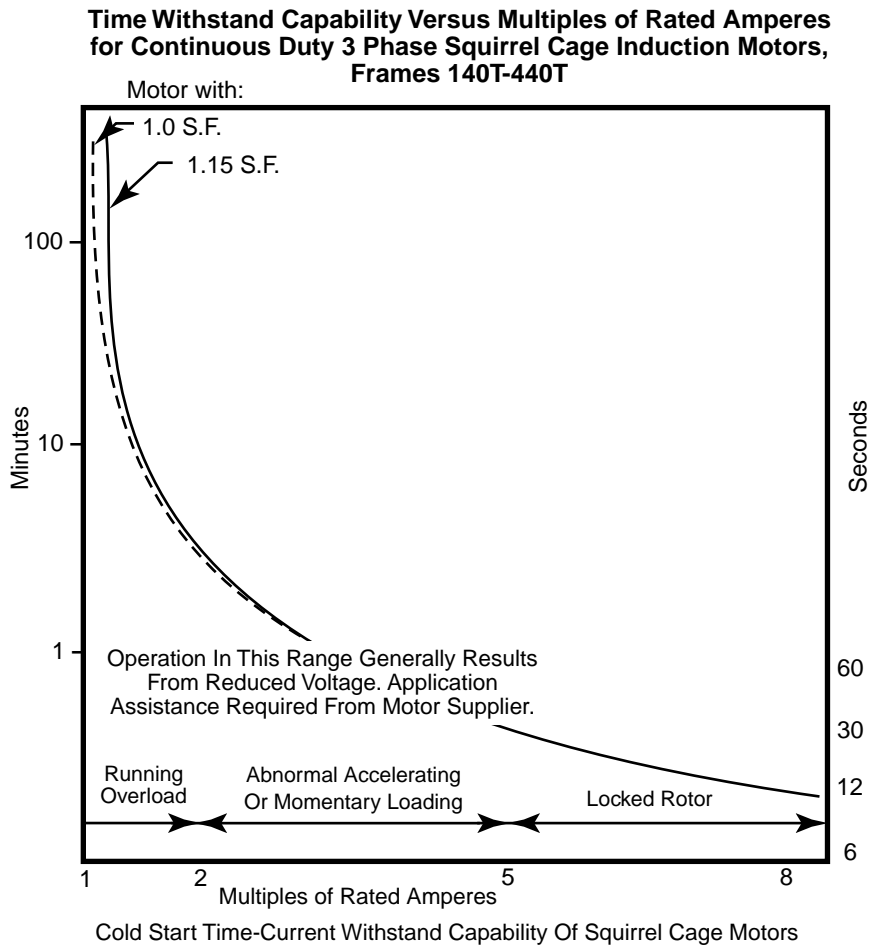

Figure 32.

## Formula for Calculating Acceleration Time

The formula used to calculate acceleration time is:

$$AT = (Wk^2 \times \Delta N) / 308T$$

In the formula,

$Wk^2$  = Total motor and load inertia (lb. ft<sup>2</sup>)

$Wk^2$  + Motor  $Wk^2$

$\Delta N$  = Change of speed (RPM)

T = Acceleration torque (lb. ft.)

AT = Acceleration Time in seconds

In this example, change in speed is from zero to full rated speed. To find T, it is necessary to find the motor torque average. A simple estimate may be found by measuring the length of several lines running between motor torque and load torque as provided by motor manufacturer's torque curves, such as the one shown. Then, divide the number by the total number of lines on the chart.

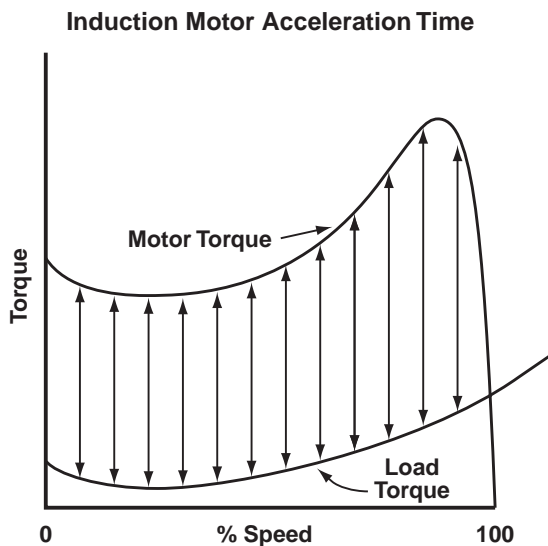

Figure 33.

## Synchronous Torque

The steady-state torque developed by a synchronous motor at rated speed.

## Peak Torque

Maximum torque a load requires from its driving motor.

## Motor Voltage

A properly sized genset must have adequate kW (power) and kVA capability to satisfy the demands of a motor during starting.

Most motors are energized with electrically operated contactors. Extremes in voltage dip due to motor starting may cause the electromagnetically held contactors to drop-out or close intermittently thus preventing the motor from starting.

Low voltage operation can cause overheating, extended load acceleration times, opening of circuit breakers, and engine/generator protection shutdowns. Shown are minimum recommended motor ratings (see Table 16).

| Minimum Recommended Motor Ratings |               |                     |                       |
|-----------------------------------|---------------|---------------------|-----------------------|
| Volts                             | RPM           | Induction Motors hp | Synchronous Motors hp |
| 601-3,000                         | 3,600         | 250                 | —                     |
| 601-3,000                         | 1,800 or less | 250                 | 250                   |
| 3,001-5,000                       | 3,600         | 350                 | —                     |
| 3,001-5,000                       | 1,800 or less | 300                 | 250                   |
| 5,001-7,000                       | 3,600         | 1,000               | —                     |
| 5,001-7,000                       | 1,800 or less | 800                 | 600                   |

Table 16.

Inrush current to the motor causes a rapid drop of generator output voltage. In most cases, 30% voltage dip is acceptable, depending on equipment already on-line. Degree of dip must be identified by an oscilloscope. Meters or mechanical recorders are too slow for this measurement.

Single-speed, three-phase, constant-speed induction motors, when measured with rated source voltage and frequency impressed and with rotor locked, must not exceed the values listed in Table 17.

## Motor Starting Techniques

There are various methods used to start motors. Those that will be discussed are full voltage, soft starting and reduced voltage.

| Locked Rotor Current — NEMA MG 1 |  |                   |            |  |                   |
|----------------------------------|--|-------------------|------------|--|-------------------|
| Horsepower                       | 60 Hz - 230 Volts<br>Locked Rotor<br>Current, Amperes* | Design<br>Letters | Horsepower | 50 Hz - 380 Volts<br>Locked Rotor<br>Current, Amperes ** | Design<br>Letters |
| 1/2                              | 20   | B,D,E             | 1 or less  | 20   | B,D,E             |
| 3/4                              | 25   | B,D,E             | 1-1/2      | 27   | B,D,E             |
| 1                                | 30   | B,D,E             | 2          | 34   | B,D,E             |
| 1-1/2                            | 40   | B,D,E             | 3          | 43   | B,C,D,E           |
| 2                                | 50   | B,D,E             | 5          | 61   | B,C,D,E           |
| 3                                | 64   | B,C,D,E           | 7-1/2      | 84   | B,C,D,E           |
| 5                                | 92   | B,C,D,E           | 10         | 107  | B,C,D,E           |
| 7-1/2                            | 127  | B,C,D,E           | 15         | 154  | B,C,D,E           |
| 10                               | 162  | B,C,D,E           | 20         | 194  | B,C,D,E           |
| 15                               | 232  | B,C,D,E           | 25         | 243  | B,C,D,E           |
| 20                               | 290  | B,C,D,E           | 30         | 289  | B,C,D,E           |
| 25                               | 365  | B,C,D,E           | 40         | 387  | B,C,D,E           |
| 30                               | 435  | B,C,D,E           | 50         | 482  | B,C,D,E           |
| 40                               | 580  | B,C,D,E           | 60         | 578  | B,C,D,E           |
| 50                               | 725  | B,C,D,E           | 75         | 722  | B,C,D,E           |
| 60                               | 870  | B,C,D,E           | 100        | 965  | B,C,D,E           |
| 75                               | 1085   | B,C,D,E           | 125        | 1207   | B,C,D,E           |
| 100                              | 1450   | B,C,D,E           | 150        | 1441   | B,C,D,E           |
| 125                              | 1815   | B,C,D,E           | 200        | 1927   | B,C,E             |
| 150                              | 2170   | B,C,D,E           |            |  |                   |
| 200                              | 2900   | B,C,E             |            |  |                   |
| 250                              | 3650   | B,E               |            |  |                   |
| 300                              | 4400   | B,E               |            |  |                   |

\*Locked rotor current of motors designed for voltages other than 230 volts shall be inversely proportional to the voltages.

\*\*The locked rotor current of motors designed for voltages other than 380 volts shall be inversely proportional to the voltages.

Table 17.

### Full Voltage Starting

The least complicated motor starting method is across-the-line (full voltage starting). As the name implies, motors are simply connected to the power source by switches in the line, as shown in Figure 34. Across-the-line starting is the most widely used motor starting method.

With full voltage starting, a momentary push button is used as the start button. When pushed, the button energizes contact coil “M”. Motor contacts “M” then close to start the motor and the seal in contact “M” holds the contacts in until the “stop” button is opened. It is not unusual for the on-off control to also include integral overload protection.

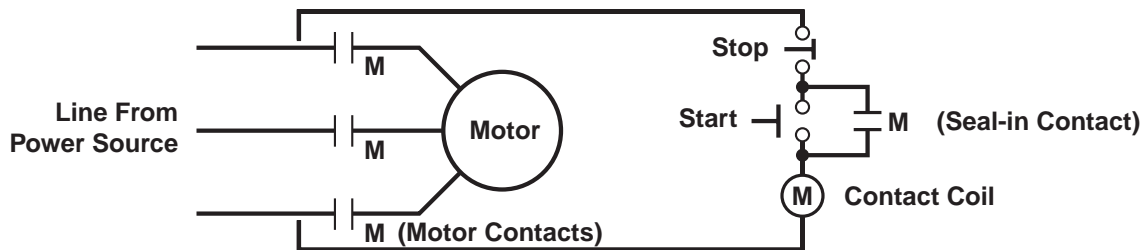

Figure 34. Full voltage starting

Full line voltage is supplied to the motor instantly when the motor switch is actuated (see Table 19 on page 52). Maximum starting torque is available; thus, the motor will have minimum acceleration time. Reduction of acceleration time is advantageous for motors that cycle off and on frequently. The shorter the time it takes the motor to get to full speed, the less heating will occur on the motor windings. This will allow for increased service life of the motor.

The generator set must have sufficient motor starting kVA capacity to limit voltage drop. If actual values of motor starting current cannot be determined, an approximate value of 600% of full-load rated current is a good approximation for Design B motors (1500% for Design E motors) (see Figure 35).

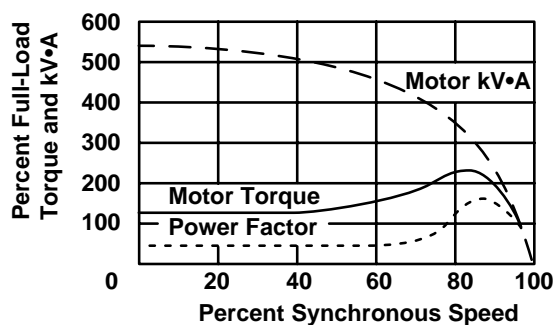

Figure 35.

Across-the-line starting is used unless there are limitations on inrush currents. Most public utilities do not allow full voltage starting of large motors. When large motors are started a relief must be provided.

### Soft Starting — Cushioning Motor Starting Under Load

Motors may be soft-started (started with decreased load or at reduced torque) to bring the load up to speed gradually or to minimize starting currents. Motors may be over stressed when developing the torque necessary to start and accelerate a large or high inertia load. Also, a high starting current may strain the electrical supply system beyond its capability to provide current to the starting motor. Three options for soft-starting motors include:

- Installing a coupling to the shaft of the motor. Doing so allows the motor to reach

full speed before the load does. Most common would be an eddy-current clutch, magnetic coupling, or variable-pitch sheave drive. This technique does relieve the generator set engine of some horsepower demand while starting, but does not relieve the generator of initial skVA demand.

- Selecting a motor with inherent soft-start characteristics.
- Interposing controls between the motor and power source to modify motor torque.

### Reduced Voltage Starting

Reduced voltage starting reduces the skVA demand on a generator set for motor starting. There is also a reduction in motor starting torque. Though a voltage dip can often cause problems, a controlled voltage dip can be beneficial. Reducing motor starting kVA can reduce the required size of the genset, reduce the voltage dip, and provide a softer start for the motor loads. However, time to reach full operating speed increases.

Shown in Figure 36 is the effect of reduced voltage on torque.

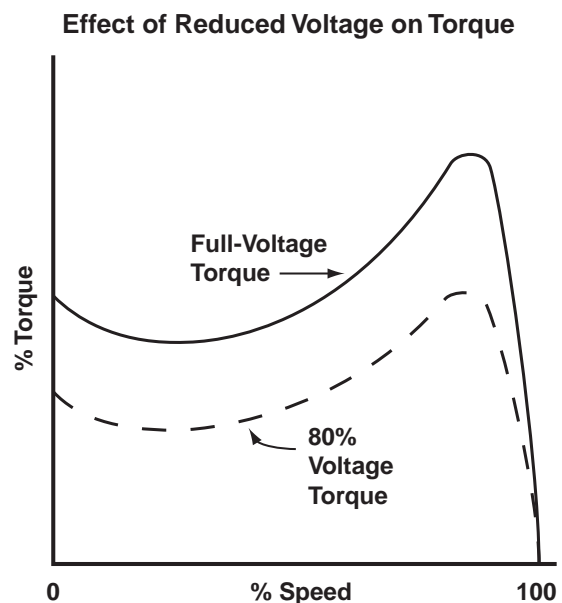

Figure 36.

Any reduction in voltage during starting sequence will have effect on both torque and load acceleration.

Starting torque varies directly with the square of the voltage impressed on the stator. If the voltage imposed on the terminals of an induction motor being started is reduced from its rated voltage to some given percentage of this full value, the power demand of the motor will be reduced to a value equivalent to the full voltage start kVA times the percent of full voltage squared.

$$\begin{aligned} \text{\% decrease of rated volts} &= x \\ x^2 &= \text{Available torque} \end{aligned}$$

Using Ohm's Law, it is seen that the power consumed in the circuit will vary directly as the square of the current flow. Therefore, since current flow in a given circuit is directly proportional to the voltage across the circuit, the result of reducing the voltage to some percent of full voltage will be a reduction in power consumed in the circuit equal to the percent of full voltage squared.

**Example:** If line voltage of 230 V is supplied to a 230 V motor, the available torque is 100%. If a 230 V motor is reduced to 200 volts, what is available torque?

**Solution:**

$$\begin{aligned} \text{\% decrease of rated volts} &= x \\ x^2 &= \text{Available torque} \\ \frac{200}{230} &= x; x^2 = 0.756 \text{ The available torque is } 75.6\% \end{aligned}$$

Reduced voltage during start can give relief from excessive current inrush demand and excessive transient disturbances. However, the motor may not have sufficient torque to accelerate to rated speed, especially if the motor is required to accelerate a connected load with a heavy inertial content.

Starting current varies directly with the impressed voltage.

**Example:** What is the current draw of a 230 V motor that is reduced to 200 V?

**Solution:**

$$\frac{200}{230} = 0.87; \text{ Current draw is } 87\% \text{ of rated.}$$

Shown is the effect of reduced voltage on current.

Effect of Reduced Voltage on Current

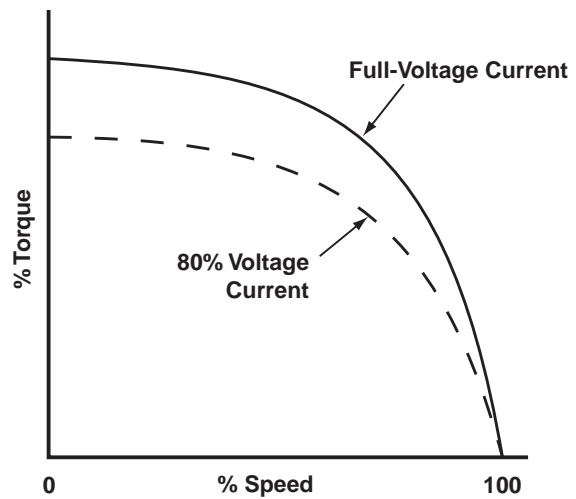

Figure 37.

There are several types of reduced motor starting: Autotransformer-Open Transition, Autotransformer-Closed Transition, Reactor, Resistor, Part Winding, Star Delta, and Solid State.

All these reduced voltage starting techniques decrease motor starting torque. Decreased motor starting torque detracts from the motors ability to start and achieve rated speed when burdened by a load. If reduced voltage starters are used, the reduction in starting torque developed by the motor must be considered.

**Types of Reduced Starting Methods**

**Autotransformer — Open Transition**

Autotransformer starters, also called auto compensators, reduce voltage to the motor terminals for starting by transformer action. They are available for very large high and low voltage motors. The autotransformer has a reduced voltage winding tap which is removed from the circuit and connected directly to the line as the motor approaches rated speed.

Autotransformer starters typically have three taps available to select 50%, 65%, or 80% of line voltage. With transformer action, current drawn from the source will vary as the square of voltage at the motor terminals. Thus, when the 80% tap is used, line current will be 80% squared or 64% of line current that would be drawn at full voltage. **With the transformer action, the autotransformer starter**

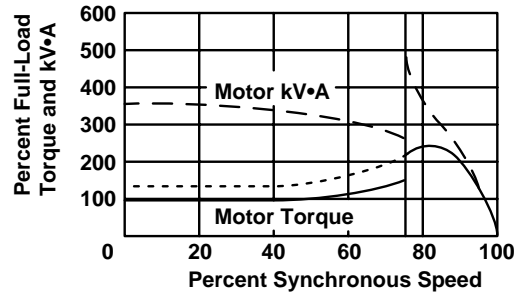
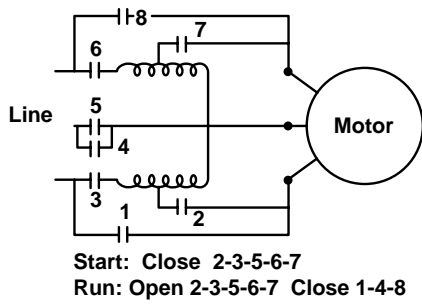

Figure 38.

**Auto Transformer — Open**

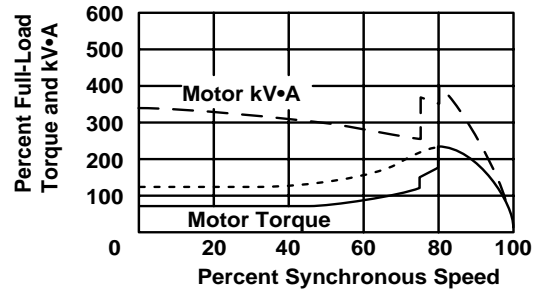
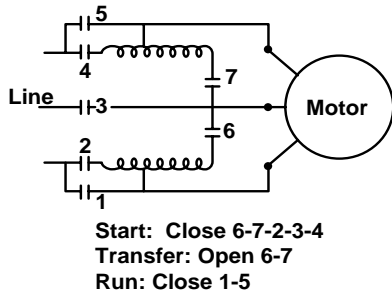

Figure 39.

**Auto Transformer — Closed**

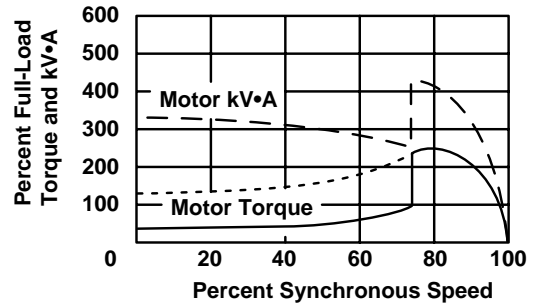
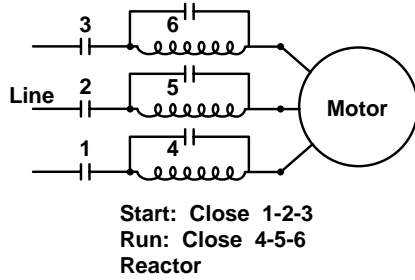

Figure 40.

**Reactor/Resistors**

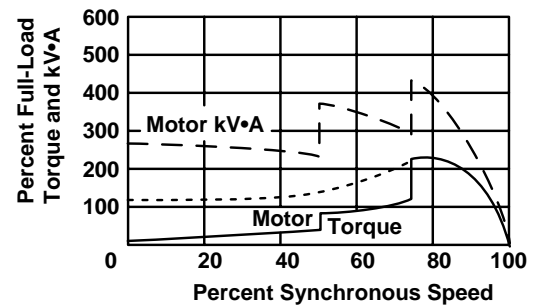
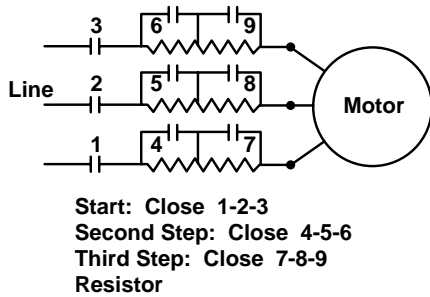

Figure 41.

**Reactor/Resistors**

**provides higher torque per ampere of line current than other types of reduced voltage starters.** Actual line current will be a few percent more than the 64% in the example because the autotransformer requires approximately 25 kVA per 100 motor horsepower for magnetizing current.

The transition to full voltage is usually determined by a timer. However, in some cases it may be done manually. The simplest arrangement is open circuit transfer from reduced to full voltage, but it causes severe electrical and mechanical disturbances during the transition switch.

### Autotransformer — Closed Transition

An alternative to open transition switching, is closed transition.

This technique minimizes shock by providing continuous flow of current while switching from autotransformer tap to full voltage. Closed transition switching, though involving slightly more complex switching, is preferred for autotransformer starting. Autotransformer starters are magnetically controlled. Three taps on the transformer secondary are set for 50%, 65%, and 80% of full line voltage. These three contactors, a timer, and a transformer make up the starting device. This starter is very smooth in acceleration and allowance starting time is 30 seconds. It is the most expensive of all starters.

Current drawn from the line will vary as the square of voltage at motor terminals. Thus, when the motor is connected to the third (80%) tap, line current will be 80%<sup>2</sup>, or 64% of line current that would be drawn at full voltage. The starter requires approximately 25 kVA per 100 motor horsepower as magnetizing current. This is added to the starting kVA of the motor being started.

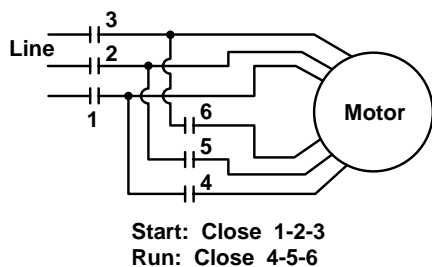

Figure 42.

### Reactor — Resistor

Reactor starters reduce voltage to the motor by inserting resistance or reactance into each leg of the circuit and then short out when the motor approaches operating speed. This type of starter uses two contactors, a timer, and a reactor or resistor as the starting device.

Allowable starting time is 5 seconds. It is the least flexible in application of all starting devices but smooth in acceleration and priced in the middle of all starters.

The added resistance acts as a voltage dropping device. It adds a loss to the circuit and imposes load on the engine. This method provides smooth acceleration as the starting circuit is removed without momentarily disconnecting motor from line. (The line current equals motor current, resulting in a lower “torque to source” kVA ratio for starting than with autotransformers.) For example, with 80% voltage applied to the motor terminals, the motor current will be 80% of normal full voltage current and likewise 80% current will be required from the line. Contrast this to 64% line current with an 80% tap autotransformer.

Reactor starting uses two contactors, a timer, and a reactor as the starting device. Allowable starting time is 15 seconds. Series reactor starting is usually used on large motors. It’s application flexibility is limited to only the high voltages and currents.

### Part Winding

A special motor with two parallel stator windings is required for part winding starting. These are successively connected to the line as motor speed increases.

Full line starting is applied to a part of the motor’s winding. Current and developed

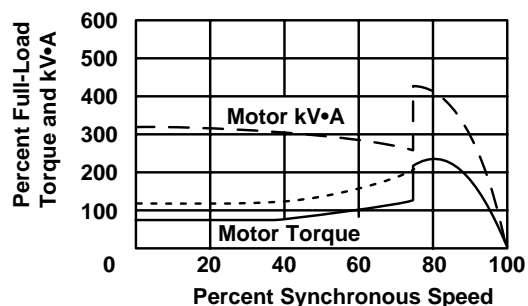

Part Winding

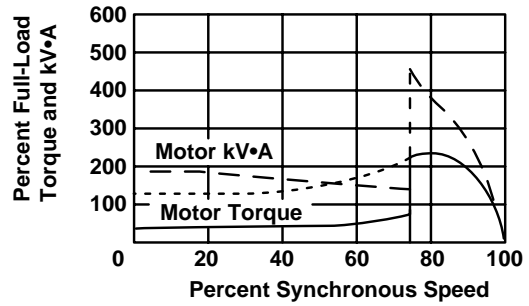
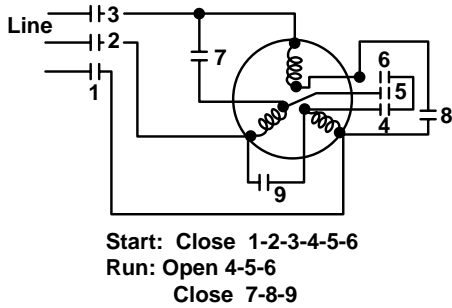

Figure 43.

### Wye (Star) — Delta

torque are reduced to that of one winding while starting. Torque characteristics are better if the stator is designed for part winding starting but standard dual voltage motors are sometimes used. Two contactors and a timer are the parts of this starter. However, an additional cost of the motor itself has to be taken into consideration since it may be up to 50% more expensive than a standard squirrel cage motor. Although this technique can produce a good torque to kVA ratio it does not allow for a smooth start and is not suitable for small, high speed motors. Acceleration time is between 5 and 15 seconds depending on the type of motor used.

### Wye (Star) — Delta

Wye-delta starting requires that the motor being started have all six or twelve leads brought out to the connection box. The motor starts as a wye (star) connected motor and is then switched to run as a delta connected motor.

When connected wye, voltage impressed on each individual winding is 58% of full value of delta connection. Starting torque and current are 33% of across-the-line value. This type of starter has the longest allowable acceleration time of 45 to 60 seconds. When wye-delta is used with a limited capacity generator set, the additional loss in the motor's starting torque due to a significant transient voltage dip usually results in the motor failing to accelerate to near rated speed prior to making transition to running mode. The power source is started almost as if it was started directly across the line, and therefore fails. **Therefore, alternators being used to power motors equipped with delta starters should be sized as if the motors were being started directly across-the-line.**

### Solid State

Solid state starters offer many options in achieving desired starting characteristics. Solid state starters adjust torque, acceleration ramp time, and current limit to cause a motor start which has a controlled acceleration. Solid state starters offer smooth, stepless motor starting by varying the conduction angle of SCR's from 20-100% to control voltage (from 40-80%) to the motor. They have the advantage of operating without moving mechanical parts and large electrical switching contacts. This provides a very smooth application of power.

### Solid State Reduced Voltage Starter

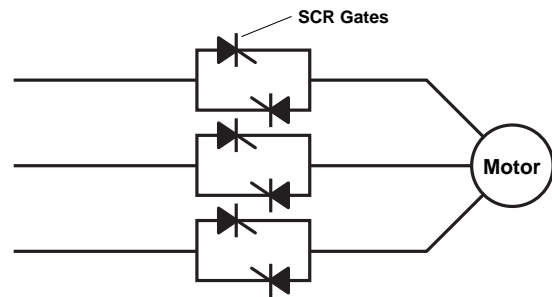

Figure 44.

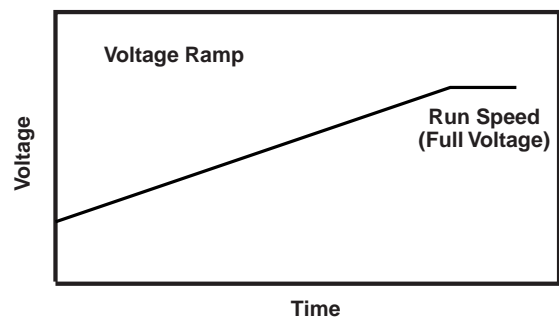

Figure 45.

Voltage/time ramp increases voltage until full voltage is applied to the motor terminals. Constant kVA is maintained, and sudden torque changes are eliminated (see Figure 45). Initial voltage step, acceleration ramp, and current limit are usually adjustable. An extended acceleration ramp time and low current limit setting results in the least voltage and frequency dips.

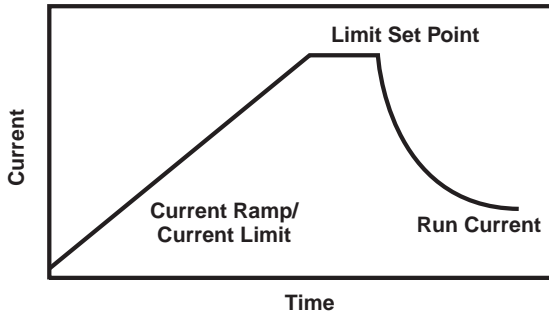

Figure 46.

Use of the current limit ramp is very common. Current is ramped up within a prescribed time to reach a programmed limit (see Figure 46). Current limit settings from 150% to 600% of full load current are typically available. A 300% limit reduces the starting kVA by 50% from the normal 600% current with full voltage across-the-line starting. Use of the current limit setting reduces motor torque available to the load (see Figure 47).

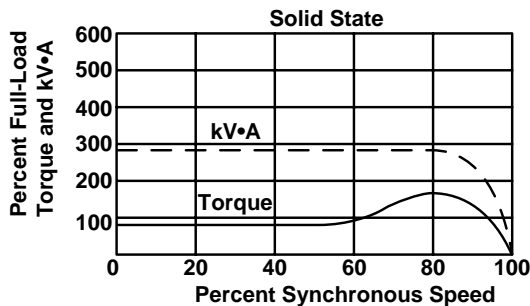

Figure 47.

The user adjusts the control to deliver the best starting characteristic for the application. Variations of current and voltage limit are sometimes used to achieve linear speed ramp, however the operating principle of the controlled parameter is always based on voltage control.

The solid state starter is not to be confused with the solid state adjustable speed drive. With a solid state starter, circuits are typically only active during starting and therefore do not require additional generator capability to accommodate voltage distortion due to the SCR's. If the solid state motor starter does not have an automatic bypass the SCR's voltage distortion will have to be compensated by oversizing the generator. A rule of thumb in this oversizing is to use two times the kW load.

The table below lists the various methods and types of starting, and their principle effects on motor starting.

| Table of Methods and Types of Motor Starting       |                         |                                 |                             |
|--|-------------------------|---------------------------------|-----------------------------|
| Method and Type of Starting                        | PU Line Voltage Applied | PU Rated Start Torque Available | PU Rated Start kVA Required |
| Full Voltage Across-the-Line                       | 1.0                     | 1.0                             | 1.0                         |
| Full Voltage Part Winding (See Notes 1 & 3)        | 1.0                     | .70                             | .70                         |
| Reduced Voltage Autotransformer (See Note 2)       | .80<br>.65<br>.50       | .64<br>.42<br>.25               | .67<br>.45<br>.28           |
| Reduced Voltage Reactor/Resistor (See Notes 1 & 3) | .80<br>.65              | .64<br>.42                      | .80<br>.65                  |
| Reduced Voltage Star-Delta                         | .58                     | .33                             | .33                         |

NOTES:

1. Values are typical. Various values of skVA and torque are available depending upon motor/starter design. Consult the motor/starter manufacturer for specific data.
2. The calculated percentage values of Start kVA have been increased by three percentage points to allow for the magnetizing kVA required for the autotransformer.
3. Values listed are typical. Consult with the customer or the manufacturer of the motor/starter for specific data.
4. In the absence of specific data, indicated typical data may be used for estimating purposes, but should be shown as "assumed values in lieu of specific data". Performance of actual equipment may vary from calculated performance on all calculations and quotations.

Table 18.

Extreme care should be given when applying reduced voltage starting to engine gensets. The amount of available starting torque is reduced. Any transient voltage dip during start will further reduce the starting torque. For example, if a motor is being started with an autotransformer starter on the 65% tap, the motor will have only 42.25% of its full voltage starting torque available upon start. If the system voltage dips 20% during transient, the voltage at the motor terminals will be only

80% of 65% of rated voltage — or 52% of full voltage. Squaring 52% gives a net value of 27% of full voltage starting torque, not the anticipated 42.25%

| Reduced Voltage Starters   |                                 |  |   |
|--|---------------------------------|--|---|
| Type of Starter  | Motor Voltage<br>% Line Voltage | Line Current<br>% Full Voltage<br>Starting Current   | Starting Torque<br>% of Full Voltage<br>Starting Torque |
| Full Voltage Starter   | 100                             | 100  | 100   |
| Autotransformer  |                                 |  |   |
| 80% Tap  | 80                              | *68  | 64  |
| 65% Tap  | 65                              | *46  | 42  |
| 50% Tap  | 50                              | *29  | 25  |
| Resistor Starter   |                                 |  |   |
| Single Step (Adjusted for motor voltage to be 80% of line voltage)   | 80                              | 80   | 64  |
| Reactor  |                                 |  |   |
| 50% Tap  | 50                              | 50   | 25  |
| 45% Tap  | 45                              | 45   | 20  |
| 37.5% Tap  | 37.5                            | 37.5   | 14  |
| Part Winding<br>(Low speed motors only)  |                                 |  |   |
| 75% Winding  | 100                             | 75   | 75  |
| 50% Winding  | 100                             | 50   | 50  |
| Star Delta   | 57                              | 33   | 33  |
| Solid State  | Adjustable                      |  |   |
| * % line current is 64%, 42% and 24% before addition of autotransformer magnetizing current.   |                                 |  |   |
| Advantages   |                                 | Disadvantages  |   |
| <b>Autotransformer</b>   |                                 |  |   |
| <ol style="list-style-type: none"> <li>1. Provides highest torque per amp of line current.</li> <li>2. Taps on autotransformer permit adjustment of starting voltage.</li> <li>3. Closed transition starting.</li> <li>4. While starting, motor current is greater than line current.</li> <li>5. Low power factor.</li> </ol> |                                 | <ol style="list-style-type: none"> <li>1. In lower hp ratings, it is most expensive design</li> </ol>  |   |
| <b>Resistor</b>  |                                 |  |   |
| <ol style="list-style-type: none"> <li>1. Smooth acceleration — motor voltage increases with speed.</li> <li>2. Closed transition starting.</li> <li>3. Less expensive than autotransformer starter in lower hp ratings.</li> <li>4. Available with several accelerating points.</li> </ol>                                    |                                 | <ol style="list-style-type: none"> <li>1. Low torque efficiency</li> <li>2. Resistor heat</li> <li>3. High power factor during start.</li> </ol> |   |
| <b>Part Winding</b>  |                                 |  |   |
| <ol style="list-style-type: none"> <li>1. Least expensive reduced voltage starter.</li> <li>2. Closed transition starting.</li> <li>3. Most dual voltage motors can be started part winding on lower of two voltages.</li> <li>4. Small size.</li> </ol>   |                                 | <ol style="list-style-type: none"> <li>1. Requires special motor design for voltages higher than 230 v.</li> </ol>                               |   |
| <b>Start Delta</b>   |                                 |  |   |
| <ol style="list-style-type: none"> <li>1. Moderate cost — less than resistor or autotransformer.</li> <li>2. Suitable for high inertia, long acceleration loads.</li> <li>3. High torque efficiency.</li> </ol>  |                                 | <ol style="list-style-type: none"> <li>1. Requires special motor design.</li> <li>2. Starting torque is low.</li> </ol>                          |   |

Table 19.

## Intermittent Starting

When a motor is run intermittently, one needs to take into consideration the transient response time. When an intermittent motor is started the voltage dip which occurs must still be in an acceptable range that does not adversely affect other loads which are already connected. All loads following the initial intermittent load (like a furnace) must include the intermittent load as part of its total as well. By taking this into account, more kVA may be needed and a larger genset may be appropriate.

## Motor Starting Troubleshooting Techniques

If motor starting is a problem, consider the following:

- Change starting sequence. Start largest motors first. More starting kVA is available, although it does not provide better voltage recovery time.
- Use reduced voltage starters. This reduces the kVA required to start a given motor. If starting under load, remember this starting method also reduces starting torque.
- Use current limiting starters.
- Specify oversized generators.
- Use wound rotor motors. They require lower starting current, but are more expensive than other motors.
- Provide clutches so motors start before loads are applied. While starting kVA demand is not reduced, time interval of high kVA demand is shortened.
- Improve system power factor. This reduces the generator set requirement to produce reactive kVA, making more kVA available for starting.

## Miscellaneous Loads

Most facilities will have both lighting and motor loads. There could be other loads in facilities besides these. Miscellaneous loads that are commonly found within a facility could include adjustable speed drives, UPS loads, single phase loads, and elevator loads.

## Adjustable (Variable) Speed Drives

Electronic adjustable speed drives are used to control speed of both AC and DC motors. Speed control allows application of motors, at their most efficient speed, to be matched to the demand created at a particular moment. Terms used to describe these drives include VSD, for variable speed drive; VFD, for variable frequency drive; AFD, for adjustable frequency drive; and ASD, for adjustable speed drive.

These drives rectify incoming AC power to form DC. The DC is used either to power a DC motor directly or power an inverter that converts DC back into AC at a desired voltage and frequency for driving a motor at any speed at any point in time.

The rectification of AC with SCR's distorts current waveforms and subsequently causes distorted voltage waveforms, which can have impact on other equipment connected to the same source.

VFD's start at zero frequency and ramp up to a set point. Variable voltage drives start at zero voltage and ramp up to a selected point. Both are under a current or torque limit to avoid large inrush current with a soft start at less than 150% of running current. A variation of the variable speed drive is the reduced voltage or reduced current starter (see description under motor starting).

As a general rule, when these drives represent more than 25% of the total load on the generator set, they become cause for concern.

VFD's require large generators. VFD's are current limiting and reduce kW and kVA. Non-linear current is drawn which have harmonics. This causes a voltage drop across the reactance of the genset. To keep total harmonic distortion (THD) to a level of 15%, additional capacity may be needed. The larger the generator, the greater reduction in impedance of the generator, which reduces the effects of the harmonic current distortion. For six-pulse VFD's twice the running kW of the drive is a typical sizing factor used to offset any reduction in starting kW or kVA. If an input filter is used to limit current to less than 10%, the sizing factor can be reduced down to 1.4 times the running kW of the drive.

Passive filters may be used to reduce the impact of harmonic distortion. However, the possible effects of leading power factor with tuned inductor/capacitor filters at start-up or with light loads may effect voltage regulation of self excited generators.

*(Refer to topic of capacitive or leading power factor loads in the Electricity chapter for additional information)*

## Silicon Controlled Rectifier (SCR) Systems

SCR drives allow infinite speed adjustment of electric motors. They are used in a variety of applications. DC motors used in elevators, cranes, and printing presses utilize SCR's. Also, AC variable frequency drives (VFD) and AC variable voltage input (VVI) drives used in pumps, fans, process conveyors, machine tools, and printing presses use SCR's.

SCR systems lend themselves to infinite speed control of motors, rectifiers, and uninterrupted power supplies (UPS). Each of these devices converts the sinusoidal supply voltage into a direct current voltage. In some cases, the equipment may convert the DC voltage back to AC voltage. Used with limited power sources, such as engine-driven generator sets, SCR switching causes severe voltage and current waveform distortion at the power source. Current waveform distortion can develop harmonic resonance in system equipment. This causes heating in motor and generator coils.

The creation of distortion with an SCR device can be shown by looking at a simple generator supplying an SCR controlled load.

### Full Conduction of SCR

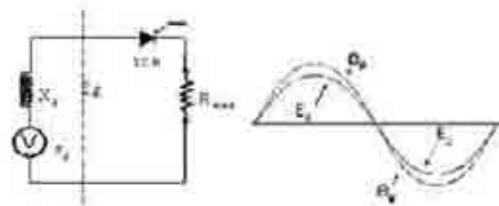

Figure 48.

Turning the SCR “on” at some point during the applied voltage cycle creates an instantaneous demand for a large amount of current to flow in the circuit. With an SCR, current does not flow until the SCR is gated “on”. This current flow results in an instantaneous voltage drop within the internal impedance or reactance of the generator. Consequently, the voltage at the generator output terminals appears as a distorted sine wave.

### SCR Triggering

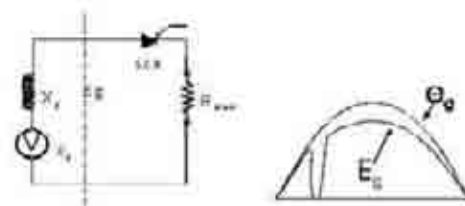

Figure 49.

Over time, these distortions which occur on a three-phase power source can cause unfavorable performance of the entire system.

When planning systems incorporating SCR devices, the control manufacturer must be informed that a limited power source (generator set) will be used. The system can then be designed to minimize distortion problems. Limiting SCR loads to 66% of a Caterpillar generator's prime power rating assures regulator control and avoids generator overheating caused by harmonics. Applications requiring high load factors must be analyzed on an individual basis.

## **Welding Loads**

Welders draw erratic fluctuating current. These current fluctuations produce voltage waveform distortion due to source impedance. Generator sets may require significant derating with welder loads.

## **Uninterruptible Power Supply (UPS)**

An Uninterruptible Power Supply system or UPS system is an assembly of equipment used with electrical loads sensitive to power source disturbances or that require absolute continuity of power. The UPS can store energy for a period of time during power outages. The UPS continually conditions power and if the normal power source is not available the UPS provides power to the critical load until the standby power generation can come on-line.

Continuity and isolation from power source disturbances can be assured by using either a rotary or static UPS system.

Rotary systems use a motor-generator set to isolate the critical load combined with kinetic inertia storage technique or batteries to carry the critical load while cranking a diesel engine.

*Static systems isolate critical load through solid state devices which use batteries to bridge power interruptions until a genset is available to power the system.*

UPS can also be used to perform an orderly engine shutdown to minimize restart damage.

Static UPS systems use static components to provide quality power to critical equipment, independent of the quality or availability of the normal power source. The simplest systems consist of a rectifier (converter), a DC storage battery bank, and an inverter.

The rectifier (sometimes called converter) is a device that converts AC to DC.

The inverter uses Solid State technology to convert DC to a waveform that is then filtered so it is suitable for powering the critical load.

A bank of storage batteries “floats” on-line to provide seamless DC power to the inverter in the event of power source loss to the rectifier. The batteries get their restoring charge and

standby float charge from the rectifier’s DC output.

The DC output of the rectifier provides for two functions during the time when an AC power source is available at it’s terminals.  
(1) It provides regulated DC to the inverter for powering the critical load.  
(2) It maintains the “state of charge” on the bank of DC batteries. (Including recharging if the state of charge has been depleted by a recent normal power outage.)

The AC output of the inverter is “conditioned power” to match the voltage and frequency requirements of the critical load at all times.

During a power interruption, power for the system comes directly from the reserve battery bank without switching. The load is seen as the static power convertor/battery charger.

## **Rectifier — Six Pulse and Twelve Pulse**

The rectifier or converter unit, which converts AC to DC in a UPS system, consists of large individual rectifiers in circuits to control the DC output. They draw current in pulses from the AC source. These current pulses are not sine wave in shape and cause voltage waveform distortion at the source supplying the UPS.

In three-phase rectifiers, the circuits and circuit elements may be arranged to provide DC power with six or twelve DC current pulses per AC input cycle.

The higher the number of pulses per cycle, the smoother the demand. Therefore, a six pulse rectifier has a more distorting demand than a twelve pulse rectifier.

Six pulse rectifiers can create a total harmonic current distortion (THD) in the range of 30-35% while twelve pulse rectifiers are more in the range of 10-12%.

For a twelve pulse UPS system where these loads are more than 25% of the generators standby rating, a generator rated for continuous duty at 105°C rise for Class F and H insulation systems should be selected.

For a twelve pulse UPS system where the loads are less than 25% of the generators standby rating, a standard generator and automatic voltage regulation system may be applied.

A six pulse UPS system should have a generator rated for continuous duty at 80°C temperature rise. An upgrade of the voltage regulation system may be necessary, as well. The subtransient reactance should also be determined before sizing the generator.

Size and cost considerations dictate the number of pulses to be used in system design. Problems with high THD with a six pulse rectifier can typically be minimized by the UPS manufacturer using a properly designed passive filter. Twelve pulse systems become more rare below 500 kVA.

### By-Pass Capability

Some UPS systems include additional components to allow the capability to by-pass the UPS in the event of failure within the system, system maintenance, or momentary overloads on the critical load side. A device called a static transfer switch allows automatic and virtually uninterrupted transfer of the critical load back to the incoming source in the event of a planned or unplanned system event such as mentioned above.

The UPS must have circuitry to ensure the inverter output and by-pass source are synchronized. Source voltage and frequency must be within an acceptable range, or the UPS will disable the automatic by-pass feature.

The demand for close control of voltage and frequency is of more concern for by-pass with a generator set source. This is because of harsh effects on voltage waveform caused by the UPS rectifier and the possibility of generator set frequency deviation due to pulsating load or small load changes. An isochronous governor is recommended on the generator set and the UPS should be adjusted or designed with the widest possible window of voltage and frequency acceptability for by-pass.

### Parallel Redundant UPS

Extremely critical applications may use a parallel redundant UPS. These are multiple UPS systems operating in parallel, typically with one or more UPS systems than required to power the load. Therefore, the critical load can be sustained even with the loss or failure of any one individual UPS system. A static switching bypass, although of lesser importance for reliability, may still be used for maintenance or momentary overload and fault clearing capability.

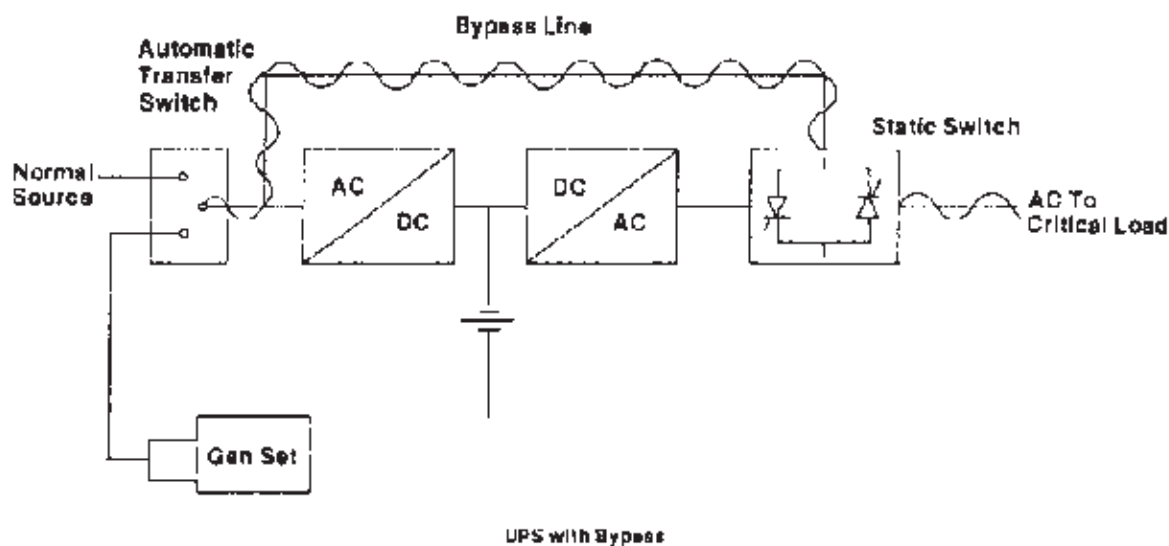
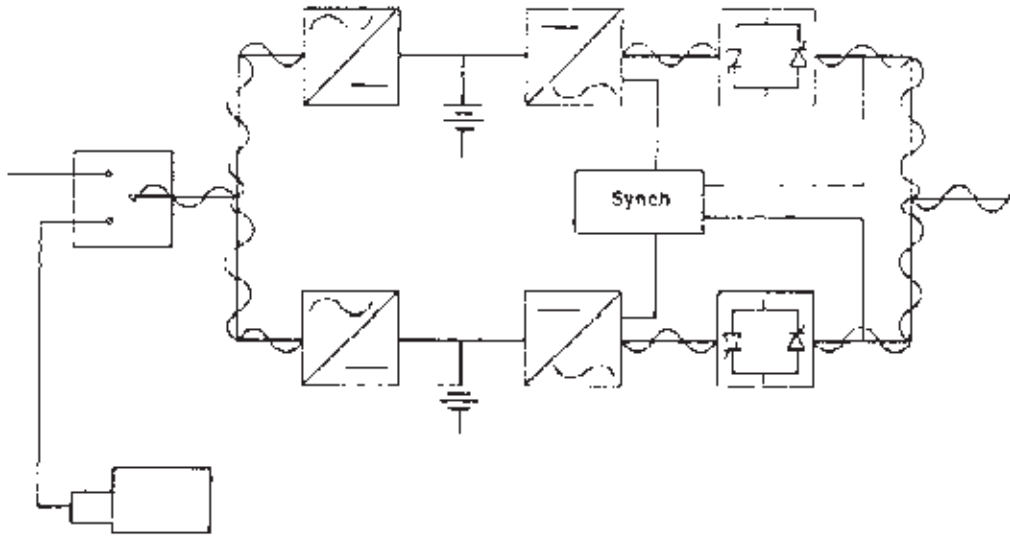

Figure 50.



**Parallel Redundant UPS**

Figure 51.

**UPS Interface**

Electrical loads sensitive to power disturbances during substation switching, voltage fluctuations, or total outages require absolute continuity of power. Continuity can be assured by isolating critical loads and incorporating one of the following:

- Assign a generator set solely to the critical load. Sudden load changes are sufficiently small to avoid speed changes.
- Isolate critical load through a motor-generator set to avoid five-cycle power interruptions of utility.

Combining the characteristics of a UPS system, particularly static systems, and a generator set present special considerations to ensure compatibility. An understanding of how these systems work and interface is essential.

A UPS is rated in output kVA. In sizing a genset, it is important to recognize the need to provide power based on UPS input. For instance, a rated UPS 100 kVA requires more than 100 kVA from the power source; the difference between input and output kVA is the efficiency of the unit. In addition, battery recharge load might be as high as 20% of the output rating.

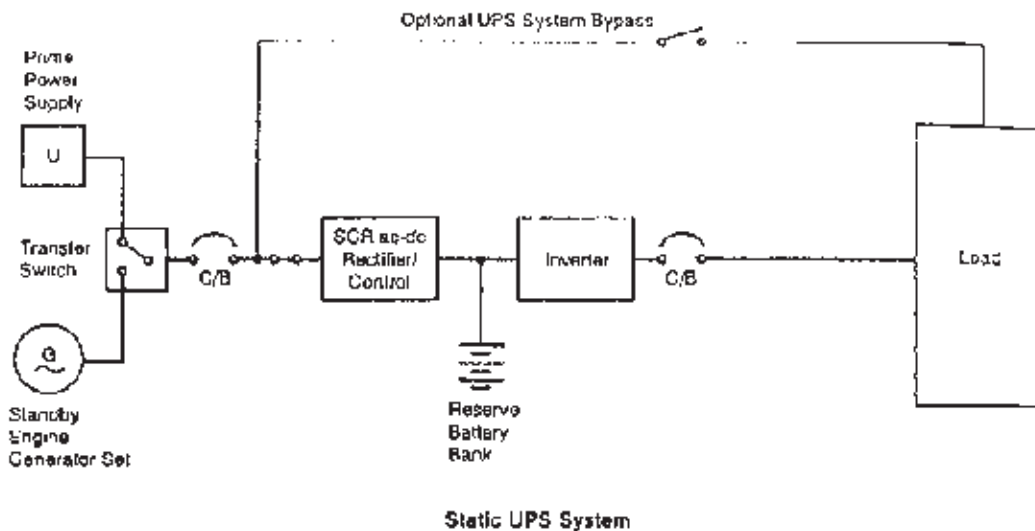

**Static UPS System**

Figure 52.

UPS systems typically have electronic circuits that discern input voltage and frequency change. All UPS should be designed or adjusted with operating parameters that are compatible with the genset. This includes using the widest possible window of voltage and frequency acceptance when used with a genset.

Coordination between the genset supplier and the UPS supplier is critical in meeting the client's needs.

### **Input Filters**

Filters may interact with other components within a system. Therefore, they should be considered very carefully. Typical tuned circuit filters represent some compromise when used with rectifiers that are exposed to broad power changes, such as may be encountered in UPS applications. Filters with capacitive reactance components may have little effect on power factor with rated load on the UPS, however, the power factor may become capacitive leading at a part-load condition.

Generator sets inherently have difficulty controlling voltage with leading power factors, and rising voltage may be observed. This condition is emphasized during UPS start-up by the power walk-in feature. Typically, a UPS has some means of gradually applying load to the source over a 10 to 20 second period. An unloaded filter may present a leading capacitive power factor load beyond the generator's voltage control capability.

Other loads connected to the generator will counter this effect. Also, disconnecting the filter at lower UPS loads will minimize the problems.

Filters may also act as stored energy devices affecting circuit switching components such as automatic transfer switches. Indiscriminate filter designs may also cause resonant conditions with other circuit elements.

### **Impact of Other Loads**

Most electrical devices and equipment are relatively unaffected when powered by generator sets with UPS loads. However, a knowledge of potentially sensitive devices may be of value in system planning. Many electronic devices contain internal AC to DC power supplies with adequate filtering and are relatively immune to waveform distortion. A few special purpose electronic or control devices that depend upon source voltage "zero crossings" for timing may perform erratically. If these devices are of low power, a simple, and low cost, filter will usually eliminate any problem.

Power factor correction capacitors are used primarily for economic reasons. They can also be effective in reducing waveform distortion. Caution must be exercised where power factor correction capacitors are used. A resonant condition at one of the harmonic frequencies with some part of the line inductance such as a transformer, on-line motor, or the generator is possible. Excessive and possibly damaging currents at the harmonic frequency can flow through the equipment. It may be advisable to keep them off line until effects of operating on an emergency generator set with non-linear loads can be observed.

### **UPS Sizing Example**

The following is a procedure to use in sizing Caterpillar Generator Sets that have static UPS systems as part or all of their load. This procedure has four parts:

**Part A:** Establish UPS input kW. Use UPS input kW from supplier data. (In this example use 255 kW.) If not available from supplier, the following procedure and guidelines are recommended to approximate or estimate UPS input kW.

$$\text{UPS Input kW} = \frac{\text{UPS Output kW} + \text{Battery Recharge kW}}{\text{UPS Efficiency}}$$

UPS output for computer loads is frequently stated in terms of kVA. For approximating, if UPS output kVA is given and kW is unknown, use 0.9 pf (typical for computer systems).

Battery recharge kW generally ranges from 0-25% of input kW (15% is typical). If unknown, use 25% of output kW for an approximation.

If UPS efficiency is unknown, the following guidelines are recommended:

- Use 0.85 if UPS < 100 kW.
- Use 0.875 if UPS > 100 kW but < 500 kW.
- Use 0.90 if UPS > 500 kW.

NOTE : Maximum input with redundant systems is less than total rating of individual systems.

**Part B:** Establish the minimum size generator to contain waveform distortion, i.e., quality of electric power.

For 6-pulse rectifier/charger:

Minimum standby rated generator set = UPS input kW  $\times$  1.6.

For 12-pulse rectifier/charger:

Minimum standby rated generator set = UPS input kW  $\times$  1.4.

**Part C:** Size the generator to accommodate other loads.

Minimum standby generator rating with other loads = (UPS input kW  $\times$  K) + kW of other loads.

Where: K = 1.15 for 6-pulse rectifier/charger.

K = 1.10 for 12-pulse rectifier/charger.

**Part D:** Compare “B” and “C” for final selection. Select larger of Part B or Part C and round to nearest larger size standby generator set.

**Example:** Select a standby generator set for powering a UPS rated 200 kVA/180 kW. Other loads connected to the generator set total 100 kW.

**Solution:**

**Part A:** From supplier data, the UPS input is 255 kW.

**Part B:** The rectifier/charger is a 6-pulse circuit, 255 kW. Minimum standby rated generator set = 255 kW  $\times$  1.6 = 408 kW.

**Part C:** Sizing for other loads.

Minimum standby generator set rating with other loads = (255 kW  $\times$  1.15) + 100 kW = 393 kW.

**Part D:** Select larger of Part B or Part C. Part B (408 kW) is larger than part C (393 kW); therefore, a standby generator set of at least 408 kW is recommended. A Caterpillar 450 kW generator set will satisfy this application.

Loads on the generator set frequently include large motors for air conditioning and other support functions. Following selection of the generator set in Part D, a check should be made to determine if the generator set has adequate motor starting skVA capability.

In special cases, it may be possible to optimize economics by selection of a generator with standby rating as determined in Part D and driving with an engine which has a standby rating commensurate with the actual total kW load on the generator set. Actual total kW load is the UPS input kW plus kW of other loads.

### Regenerative Power

Some motor applications, such as hoisting, depend on motors for braking.

If a mechanical load causes the motor to turn faster than synchronous speed, the motor will act as a generator and feed power back into the system. The term “regenerative power” is sometimes used to describe the power produced by these loads. If no other loads are connected to absorb this energy, these loads will cause the generator to act as a motor, possibly causing engine overspeed which can lead to engine failure.

Only engine frictional horsepower can be relied on for braking. Exceeding frictional horsepower causes the generator set overspeed.

In calculating the ability of a system to overcome regenerative power, it is conservatively recommended that only engine friction horsepower be considered. Engine friction horsepower at synchronous speeds is available from the engine manufacturer. Typically, a generator set will retard approximately 10% of its rating.

When combinations of connected load and engine frictional horsepower are not sufficient to restrain regenerative energy, load banks may be added to protect the genset from being affected regeneration.

## Transformers

Transformers are used in power distribution systems for voltage step-up, voltage step-down, or circuit isolation purposes. They are commonly used to step-down transmission line voltage to a useable distribution system voltage and to step-down service or supply voltage to the utilization voltage of user equipment.

### Transformer Magnetizing Current

When a transformer is initially energized, there is an inrush of current to bring it from a residual flux level to normal steady state flux level. Transformers have inductive characteristics similar to motors when charging, with inrush (magnetizing) current as much as 40 times full load current when connected to a utility power source. With a generator source, values of generator subtransient reactance ( $X''_d$ ) limit the inrush current to values of 6 to 10 times generator rated current. However, the process of flux build-up in transformer excitation takes only a few cycles before current returns to a relatively low exciting current level. The affect on the generator set can be ignored, but, if voltage fluctuation to highly sensitive equipment must be closely controlled, kVA capability of the power source must include starting of this low power factor load.

Generators are quite capable of energizing a transformer, even in cases where the transformer kVA rating is several times greater than generator kVA rating. A voltage dip occurs at the generator terminals, almost as if a short circuit had occurred. However, transformer flux builds up in a few cycles and voltage is restored.

### Transformer Efficiency Losses

Power transformers are relatively efficient. Typical efficiencies are 95 to 99% at full load. The efficiency is the ratio of real power output to power input. Losses are mainly losses incident to magnetization at no-load and the addition of  $I^2R$  losses caused by the load current.

### Transformer Taps

Transformer taps can be used to adjust voltage levels. Transformers consist of a primary coil and a secondary coil. The coil winding of a transformer can be tapped to change the turns ratio and adjust the voltage level of a system.

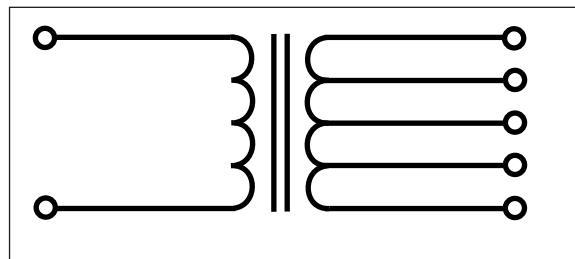

Figure 53.

**Example:** To better understand transformer taps, take a look at the 4160 V to 480 V distribution step-down system (see Figure 54).

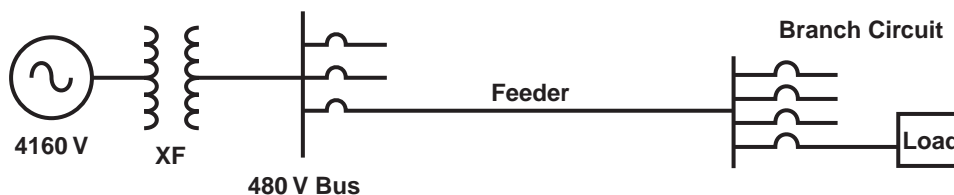

Figure 54.

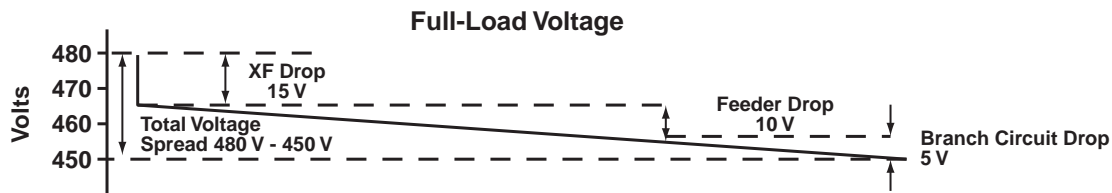

Figure 55.

On the system, voltage is dropped from 480 V at the bus to 450 V at the load. But, what if that load required more voltage than 450 V from the 4160 V generator?

**Solution:** One way to remedy the situation is with a -5% transformer tap, which increases voltage at the load to 474 V. Keep in mind that the tap adjusts the overall voltage level. It does not change the voltage spread. In this example, voltage at the transformer would have been increased from 480 V to 504 V. An automatic regulator on a generator set could have also been used to adjust overall voltage, instead of a transformer tap.

Transformers have a variety of taps. Table 20 is an example of taps found in a 4160-480 V transformer.

| 4160-480 Volt Transformer Taps |                   |               |
|--------------------------------|-------------------|---------------|
| Primary Voltage                | Secondary Voltage | Tap           |
| 3952                           | 480               | -5%           |
| 4056                           | 480               | -2½%          |
| 4160                           | 480               | Normal rating |
| 4264                           | 480               | +2½%          |
| 4368                           | 480               | +5%           |

Table 20.

### Critical Loads

Critical loads are loads that cannot tolerate voltage and frequency dips. Data centers, communication equipment and medical equipment are examples of critical loads.

#### Data Centers/Computers

Data centers require a reliable power source. Power quality requirements should be considered prior to power system design. As a general rule, avoid heavy SCR loads, block switching loads, and large motor skVA on data processing equipment power circuits.

### Communications Equipment

Communication equipment includes broad ranges of electronic devices for transmission of information. Most common are radio and television broadcasting equipment, studio equipment, transmitters and telephone equipment. Generally, all devices pass their power supply through transformers. Therefore, power factor is slightly less than unity. Most equipment tolerates frequency variations of  $\pm 5\%$ , except where synchronous timing from the power source is used. Voltage variations of  $\pm 10\%$  are usually acceptable since electronic circuits sensitive to voltage variations contain internal regulation circuitry.

Power for complex telephone systems is frequently supplied from building system mains. Voltage and frequency stability requirements are usually not severe, however solid-state battery charging equipment may be part of the load and create disturbance to a generator power source.

### Medical Equipment

X-Ray equipment typically needs very short duration, high voltage from power supplies. This need results in high current draw in short durations, which in turn results in low kW demand at near unity power factor.

Power source equipment should be selected to maintain x-ray quality. As x-ray equipment is activated, voltage dip due to inrush should be within 10% or within the manufacturer's recommended tolerance.

These loads generally represent only a small part of the generator load, so x-ray pictures are not normally affected.

## Helpful Load Application Tips

Some rules of thumb can be used if the smallest, but most effective on-site system is required:

- Across-the-line motors when started, should always have the largest motor started first and then smaller motors sequentially after that.
- When motors with electronic drives are started, the “largest motor first” rule doesn’t necessarily apply. Electronic drives allow better control of the load by controlling the maximum current load and rate of load application. These loads are more sensitive to voltage variation than the motors started “across-the-line”
- When UPS loads are present, load them last. Generators are more stable and less affected by non-linear loads when linear loads have been running before non-linear ones are applied.
- Loads that have filters or use power factor correction for power quality improvement should not be applied to a light load level. The capacitive elements of these loads make the generator susceptible to huge voltage increases.

## Line Losses

Wires and cables in circuits always have some resistance to current flow. This presents a power loss and a voltage drop. The amount of loss in a system may not be significant, however it should be given consideration. The actual power loss in kW is typically not high, when considering loads, for generator set sizing.

Line voltage drop may be a more important consideration. Voltage drop can represent a significant difference between generated voltage and voltage delivered at the load. Line voltage drop change with load change also affects voltage regulation at the load, if the load varies.

Power losses are calculated as  $I^2R$  loss in watts or kilowatts. Voltage drop is calculated as  $I^2R$  loss. The amount of resistance is based on length, cross-sectional area, temperature, and substance of the conductors. Standard

electrical handbooks contain tables of resistivity of wire and cable for making calculations. Line losses are not typically a factor with short cable lengths of proper size.

## Power Factor Loads

Self excited, synchronous generators are not designed to operate with leading power factor load. The AC voltage generated is controlled by DC excitation. The amount of excitation required is a function of generator load.

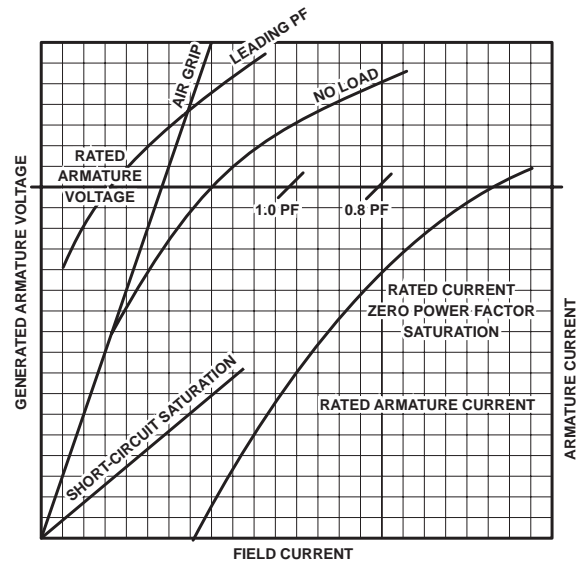

Figure 56.

Excitation required to maintain constant voltage, increases with load. Reactive lagging power factor load requires more excitation than a unity power factor load. Leading power factor loads require less excitation than unity power factor loads. When a generator has a leading power factor, the armature flux reacts additively with the field pole flux to increase saturation and produce a higher terminal voltage for a given amount of excitation.

The automatic voltage regulator responds to control voltage by reducing excitation. At light load, the regulator will go to it’s minimum excitation capability. However, the additive excitation from a leading power factor will cause the terminal voltage to rise and will not be controlled by the voltage regulator.

It is not uncommon for this condition to occur with power factor correction capacitors or tuned circuit filters, which are connected to circuits at light load conditions. This same phenomena can occur when energizing long transmission lines due to distributed capacitance. Adding reactance to the circuit is a possible solution to overcome the problem should it occur.

### Long Transmission Lines

Long transmission lines may require the effects of distributed line capacitance to be taken into account. The definition of a “long” transmission line is a relative term and difficult to define for a generator set application. However, as can be seen by the equivalent circuit of a transmission line, there is distributed capacitance between the lines and ground (see Figure 57).

The line charging current varies with voltage, length, height, and line spacing along with other factors.

A problem arises, particularly with an unloaded line, where the line charging load appears as a leading power factor load to the generator. Power factors of 0.95 leading or more may result in the generated voltage going uncontrolled to the limit of the generator saturation curve upon energization of the line. Having some lagging reactive load on-line will correct or avoid this problem should it occur.

### Two-wire Circuit Power Loss Formula

The formula for calculating the power losses for a two-wire circuit (DC or single-phase) is:

$$\frac{24 \times L \times I^2}{CM} = P$$

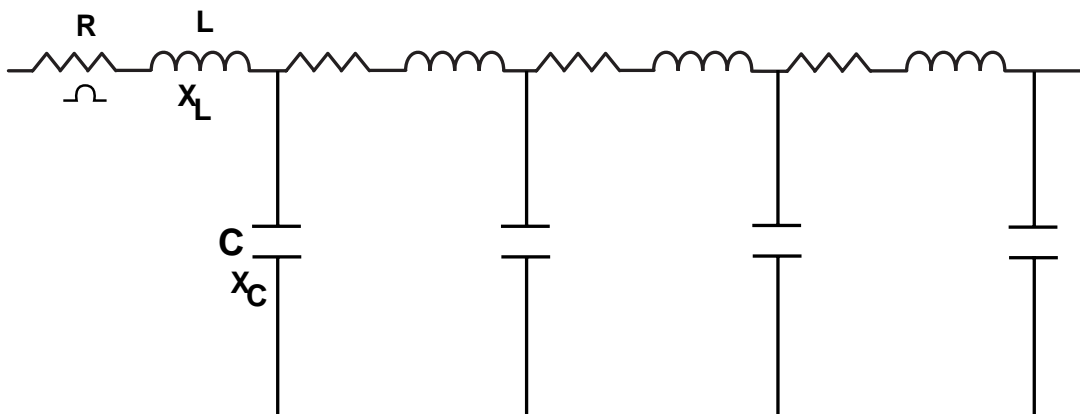

Figure 57.

“P” = power loss in watts

“L” = one-way length of a circuit in feet

“CM” = the cross section of a conductor in circular mils

“I” = represents current.

### Two-wire Circuit Power Loss Example

Assume a single-phase motor rated to deliver 7.5 hp at 115 V is connected to a power source via a 200 foot, No. 1 AWG copper wire sized at 83,690 CM. Also assume the motor draws 80 amperes at full load. What is the power loss?

#### Solution:

Use the formula for a single-phase motor:

$$\frac{24 \times 200 \times 80^2}{83,690} = P = 367 \text{ watt power loss}$$

### Three-wire Circuit Power Loss Formula

The formula used to calculate power for a three-wire circuit (assuming a balanced load) is:

$$\frac{36 \times L \times I^2}{CM} = P$$

### Three-wire Circuit Power Loss Example

Assume a three-phase motor rated to deliver 100 hp at 230 V connected to the power source via a 400 foot cable sized at 250 MCM. Also assume the motor draws 248 amperes at full load.

What is the power loss?

#### Solution:

Use the three-phase formula:

$$\frac{36 \times 400 \times 248^2}{250,000} = P = 3,543 \text{ watt power loss}$$

## Single-Phase Loads

In three-phase power generation, a single-phase load is a load placed across one voltage phase of the generator.

If single-phase loads are added to the three-phase system, a condition of unbalance will exist unless the single-phase loads are equally distributed among each of the three phases of the generator set.

Tests have shown that phase-voltage unbalance of more than 2% in three-phase will cause motor overheating, if the motor is operating close to full load. Some electronic equipment may also be affected by an unbalance of more than 2%.

### Load Balancing

If the electrical distribution system served by a three-phase generator set consists entirely of three-phase loads, the system is balanced. The coils making up the generator's three phases each supply the same amount of current to the load. If single-phase loads are added to the three-phase load, however, a condition of unbalance will exist unless the single-phase loads are equally distributed among each of the three phases of the generator set.

Generators operate best with balanced loads. If the loads are unbalanced the risk of overheating is probable. When sizing a generator all loads should be balanced.

In many applications, balancing of single-phase loads may not be practical. If these loads are small (10% or less of the generator set three-phase kVA capacity), unbalanced single-phase loading is not cause for concern provided any of the three line currents do not exceed the generator set rated line current.

To determine the maximum single-phase load which may be safely drawn from a generator set supplying single-phase and three-phase power simultaneously, use Table 20 to help with calculations:

### Example:

Find the amount of single-phase power which can be safely drawn from a three-phase 120/240 volt four-wire generator set rated to deliver 100 kW at a 0.8 power factor. The coil

current rating of the generator set is 334 amperes. Assume that the single-phase load is connected from one line-to-neutral and has an operating power factor of 0.9 lagging, and that the generator set is also supplying a three-phase load of 50 kW at a power factor of 0.08

### Solution:

1. Find the current drawn from each of the lines by the three-phase load.

$$P = \frac{1.732E \times I \times \text{pf}}{1000} = I = \frac{P \times 1000}{1.732 \times E \times \text{pf}} = \frac{50 \times 1000}{1.73 \times 240 \times 0.8} = 151 \text{ amperes}$$

2. Find the coil current capacity remaining for the single-phase load:

$$334 - 151 = 183 \text{ amperes}$$

3. Find the single-phase power available:

$$P = \frac{E \times I \times \text{pf}}{1000} = \frac{125 \times 183 \times 0.9}{1000} = 20.6 \text{ kW}$$

### Example:

The generator set is rated to deliver 100 kW at a 0.8 power factor. It is a three-phase machine with a coil current rating of 334 amperes. The three-phase load to be supplied is 50 kW at 0.8 power factor. The single-phase load consists of both 125 and 216 volt circuits. The 125 volt load has a power factor of 0.9 and is connected from neutral to one leg. This leg is common with one of the two supplying 10 kW at a 0.8 power factor to the 216 volt load.

### Solution:

1. The current drawn from each line by the three-phase load is found by the procedure used in step one of the previous example.

2. The coil capacity available for single-phase loads is also the same as in example 1; 167 amperes.

3. Find the 216 volt single-phase load current:

$$I = \frac{P \times 1000}{E \times \text{pf}} = \frac{10 \times 1000}{216 \times 0.8} = 58 \text{ amperes}$$

4. Find the coil current capacity remaining for the single-phase 125 volt load:

$$167 - 58 = 109 \text{ amperes}$$

5. Find the 125 volt single-phase power available:

$$P = \frac{E \times I \times \text{pf}}{1000} = \frac{125 \times 109 \times 0.9}{1000} = 12.3 \text{ kW}$$

### One-line Diagrams

One-line diagrams greatly simplify load and system analyses.

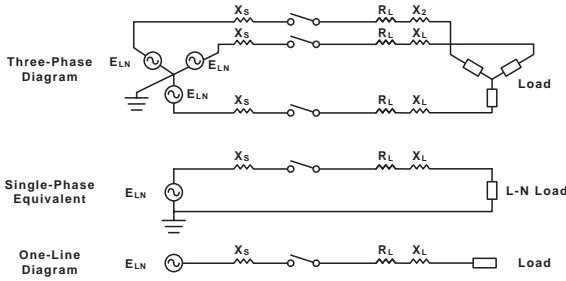

Figure 58.

The one-line diagram shown represents a balanced system. In the top diagram, the generator is shown in its three phases, which

are separated with an  $E_{LN}$  line-to-neutral voltage.  $X_s$  represents generator reactance.  $R_L$  and  $X_L$  are load resistance and load reactance, respectively. The middle diagram illustrates the single-phase equivalent of all three phases. The bottom diagram is a further simplification of the same thing. A simplified diagram is often used in three-phase representation.

### Final Example: Generator Set Sizing

Figures 59 and 60 will be used to detail how to size a Caterpillar generator set, using load information. Figure 60 is used when motors with NEMA code letters are considered.

1. Fill out information in Part I. and II. from nameplate information. The motor efficiency can be estimated using a chart of approximate efficiencies (see Table 23 at end of this example).
2. Total engine load is determined by calculating motor efficiencies and adding to resistive load: Add the lighting loads, other non-motor loads, and motor loads together.

Customer \_\_\_\_\_ Project \_\_\_\_\_ Analyst \_\_\_\_\_ Date \_\_\_\_\_

**I. APPLICATION DATA**  
 Prime/Standby Power \_\_\_\_\_ Gas/Diesel Fuel \_\_\_\_\_ Vols \_\_\_\_\_ Phase \_\_\_\_\_ Hz \_\_\_\_\_

**II. LOADS**  
 A. Lighting Loads \_\_\_\_\_  
 B. Other Non-Motor Loads \_\_\_\_\_  
 C. Motors \_\_\_\_\_

| Starting Sequence             | Motor kW | Full Load Amps | Locked Motor Amps | Reduced Voltage Starting | Acceptable Voltage Dip Percent | Motor Eff. (Chart 5) | kW (Engine) |
|-------------------------------|----------|----------------|-------------------|--------------------------|--------------------------------|----------------------|-------------|
| 1                             |          |                |                   |                          |                                |                      |             |
| 2                             |          |                |                   |                          |                                |                      |             |
| 3                             |          |                |                   |                          |                                |                      |             |
| 4                             |          |                |                   |                          |                                |                      |             |
| 5                             |          |                |                   |                          |                                |                      |             |
| Total Motor Load              |          |                |                   |                          |                                |                      | kW          |
| Total Engine Load (A + B + C) |          |                |                   |                          |                                |                      | kW          |

**III. ENGINE SIZING**  
 kW (Motor) \_\_\_\_\_  
 kW (Engine) \_\_\_\_\_

**IV. ENGINE SELECTION Model:**  
 Frame: \_\_\_\_\_ Rating (With Fan): \_\_\_\_\_ kW \_\_\_\_\_ Hz \_\_\_\_\_ rpm

**V. GENERATOR SIZING Start Sequence**

|  | Motor(s) 1 | Motor(s) 2 | Motor(s) 3 | Motor(s) 4 | Motor(s) 5 |
|--|------------|------------|------------|------------|------------|
| A. Starting kVA (SKVA)   |            |            |            |            |            |
| 1. Locked Motor Amps (Use 8.0 x Full Load Amperes if LRA Unknown), Ref: to Chart 4 if Full Load Amps Unknown | LRA        | LRA        | LRA        | LRA        | LRA        |
| 2. SKVA = $LRA \times V \times 1.732$  | SKVA       | SKVA       | SKVA       | SKVA       | SKVA       |
| B. Effective SKVA  |            |            |            |            |            |
| 1. All Motors Running  | kW         | kW         | kW         | kW         | kW         |
| 2. All Motors Running & Motor Being Started  | kW         | kW         | kW         | kW         | kW         |
| 3. $\frac{B.1}{R^2} \times 100$  | %          | %          | %          | %          | %          |
| 4. Compensation for Motors Already Started (Chart 2)   | 1.0        |            |            |            |            |
| 5. Step A.2 x Step B.4   | SKVA       | SKVA       | SKVA       | SKVA       | SKVA       |
| 6. Reduced Voltage Factor (Chart 3) (use 1.0 if no starting aid used)  |            |            |            |            |            |
| 7. Effective SKVA = Step B.5 x D.F.  | SKVA       | SKVA       | SKVA       | SKVA       | SKVA       |
| 8. Acceptable Voltage Dip (10, 20, 30%)  | %          | %          | %          | %          | %          |
| C. Generator Selection (Chart 1)   |            |            |            |            |            |
| 1. Frame   |            |            |            |            |            |
| 2. Rating  | kW         | kW         | kW         | kW         | kW         |
| 3. SKVA at Selected Voltage Dip  |            |            |            |            |            |

**VI. GENERATOR SET SIZING**  
 Select Largest Generator Set Model of Step IV and Step V.C.1.)  
 Model: \_\_\_\_\_ Frame: \_\_\_\_\_ Rating: \_\_\_\_\_ kW Prime/Standby \_\_\_\_\_ Hz \_\_\_\_\_ rpm

Figure 59.

Customer \_\_\_\_\_ Project \_\_\_\_\_ Analyst \_\_\_\_\_ Date \_\_\_\_\_

**I. APPLICATION DATA**  
 Prime/Standby Power \_\_\_\_\_ Gas/Diesel Fuel \_\_\_\_\_ Voltage \_\_\_\_\_ Phase \_\_\_\_\_ Hz \_\_\_\_\_

**II. LOADS**

A. Lighting Loads \_\_\_\_\_ kW  
 B. Other Non-Motor Loads \_\_\_\_\_ kW  
 C. Motors

| Starting Sequence | hp    | Nema Code | Nameplate Data                |                                | Motor Eff. Chart 2 | kW (Engine) = hp (Motor) x 0.746 | Motor Efficiency Chart 2 |
|-------------------|-------|-----------|-------------------------------|--------------------------------|--------------------|----------------------------------|--------------------------|
|                   |       |           | Reduced Voltage Starting Type | Acceptable Voltage Dip Percent |                    |                                  |                          |
| 1                 | _____ | _____     | _____                         | _____                          | _____              | _____                            | _____ kW                 |
| 2                 | _____ | _____     | _____                         | _____                          | _____              | _____                            | _____ kW                 |
| 3                 | _____ | _____     | _____                         | _____                          | _____              | _____                            | _____ kW                 |
| 4                 | _____ | _____     | _____                         | _____                          | _____              | _____                            | _____ kW                 |
| 5                 | _____ | _____     | _____                         | _____                          | _____              | _____                            | _____ kW                 |

Total Motor Load \_\_\_\_\_ kW  
 Total Engine Load (A+B+C) \_\_\_\_\_ kW

**III. ENGINE SIZING**  
 Model: \_\_\_\_\_ Frame: \_\_\_\_\_ Rating (With Fan): \_\_\_\_\_ kW \_\_\_\_\_ Hz \_\_\_\_\_ rpm

**IV. ENGINE SELECTION**

**V. GENERATOR SIZING Start Sequence**

|   | Motor(s) 1 | Motor(s) 2 | Motor(s) 3 | Motor(s) 4 | Motor(s) 5 |
|---|------------|------------|------------|------------|------------|
| A. Starting kVA (SKVA)  |            |            |            |            |            |
| 1. Motor Ratings  | _____ hp   | _____ hp   | _____ hp   | _____ hp   | _____ hp   |
| 2. NEMA Code  | _____      | _____      | _____      | _____      | _____      |
| 3. SKVA/hp (Use 6.0 if Code Letter Unknown)                           | _____ SKVA | _____ SKVA | _____ SKVA | _____ SKVA | _____ SKVA |
| 4. SKVA/hp x Motor hp (A 1 x A 3)                                     | _____ SKVA | _____ SKVA | _____ SKVA | _____ SKVA | _____ SKVA |
| B. Effective SKVA   |            |            |            |            |            |
| 1. All Motors Running   | _____ kW   | _____ kW   | _____ kW   | _____ kW   | _____ kW   |
| 2. All Motors Running & Motor Being Started                           | _____ kW   | _____ kW   | _____ kW   | _____ kW   | _____ kW   |
| 3. B1   | _____ %    | _____ %    | _____ %    | _____ %    | _____ %    |
| 3. B2   | _____ %    | _____ %    | _____ %    | _____ %    | _____ %    |
| 4. Compensation for Motors Already Started (Chart 2)                  | 1.0        | _____      | _____      | _____      | _____      |
| 5. STEP A 4 x Step B 4  | _____ SKVA | _____ SKVA | _____ SKVA | _____ SKVA | _____ SKVA |
| 6. Reduced Voltage Factor (Chart 3) (Use 1.0 if no starting aid used) | _____      | _____      | _____      | _____      | _____      |
| 7. Effective SKVA = Step B 5 x D 6                                    | _____ SKVA | _____ SKVA | _____ SKVA | _____ SKVA | _____ SKVA |
| 8. Acceptable Voltage Dip (10, 20, 30%)                               | _____ %    | _____ %    | _____ %    | _____ %    | _____ %    |
| C. Generator Selection (Chart 1)                                      |            |            |            |            |            |
| 1. Frame  | _____ kW   | _____ kW   | _____ kW   | _____ kW   | _____ kW   |
| 2. Rating   | _____ kW   | _____ kW   | _____ kW   | _____ kW   | _____ kW   |
| 3. SKVA at Selected Voltage Dip                                       | _____ kW   | _____ kW   | _____ kW   | _____ kW   | _____ kW   |

**VI. GENERATOR SET SIZING**  
 Select Largest Generator Set Model of Step IV and Step V.C.1.  
 Model: \_\_\_\_\_ Frame: \_\_\_\_\_ Rating: \_\_\_\_\_ kW Prime/Standby \_\_\_\_\_ Hz \_\_\_\_\_ rpm

Figure 60.

3. Select engine (Part IV) which matches frequency (Hz), configuration (gas, diesel, turbocharged, aftercooled, naturally aspirated), speed, and load. Hz and configuration are found in Section I. Speed is by customer preference and the load was determined in Section II.
4. Generator Sizing: In Section V fill in Part A for all motors from nameplate. Minimize starting requirements by starting the largest motors first. The motors rating and NEMA code can be found in Section II. The skVA/hp is found using the NEMA code letter chart (see Table 14).

Find the Starting skVA using the following formula:

$$\text{skVA} = \frac{\text{LRA} \times V \times 1.732}{1000}$$

5. Motors on-line diminish skVA to start additional motors. For column B1 the first motor is always 0 if there is more than one motor. Motor #2 space is the kW in Section II from first sequence motor. Additional motor's kW are added to the total for each motor starting.

B2 columns are filled in using Section II information as written. B3 uses the Motor Preload Multiplier formula to determine the percentage of motor load: B1/B3 or

$$\% \text{ Motor Load} = \frac{\text{All Motors Running}}{\text{All Motors Running \& Being Started}} \times 100$$

Under 40%, the multiplier is 1.0. Over 40% use the chart in Figure 61.

## kVA of AC Circuits

Single-Phase, Two-Wire

$$\text{kVA} = \frac{V \times I}{1000}$$

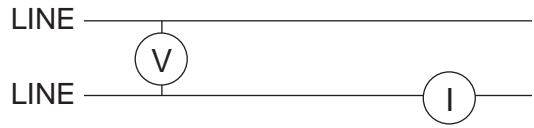

Single-Phase, Three-Wire — Balanced

$$\text{kVA} = \frac{V \times I}{1000}$$

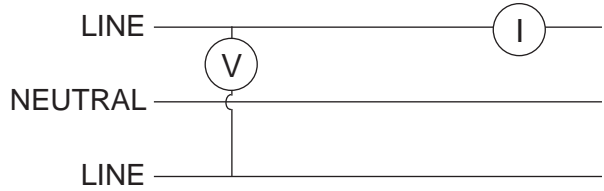

Single-Phase, Three-Wire — Unbalanced

$$\text{kVA} = \frac{V_1 \times I_1 + (V_2 \times I_2)}{1000}$$

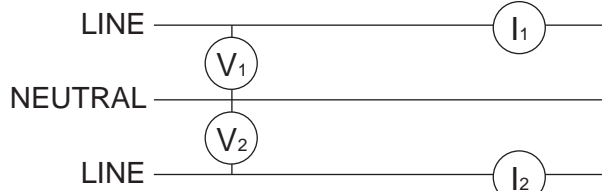

Three-Phase, Three-Wire — Balanced

$$\text{kVA} = \frac{1.732 \times V \times I}{1000}$$

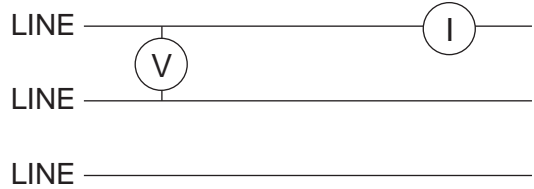

Three-Phase, Three-Wire — Unbalanced

$$\text{kVA} = \frac{1.732 \times V \times \left(\frac{I_1 + I_2 + I_3}{3}\right)}{1000}$$

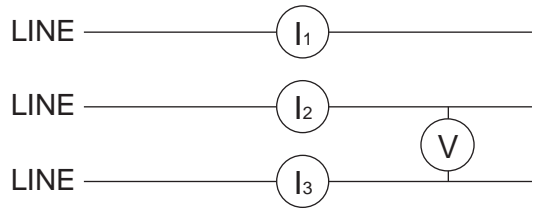

Three-Phase, Four-Wire — Balanced

$$\text{kVA} = \frac{3 \times V \times I}{1000}$$

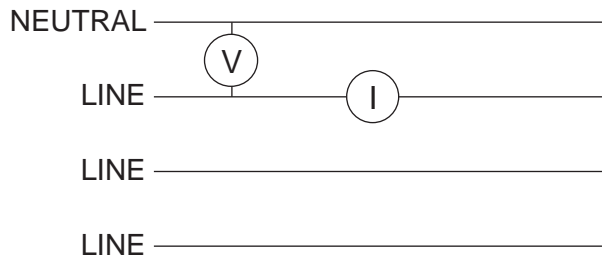

Three-Phase, Four-Wire — Unbalanced

$$\text{kVA} = \frac{3 \times V \times \left(\frac{I_1 + I_2 + I_3}{3}\right)}{1000}$$

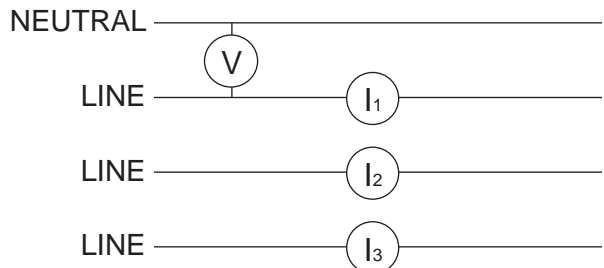

Table 21.

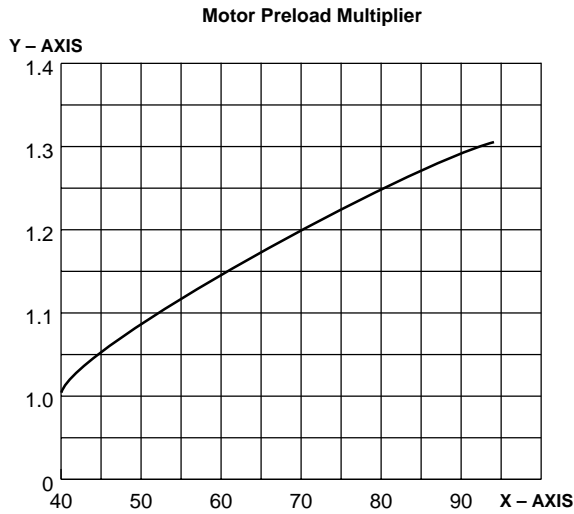

Figure 61.

$$\% \text{ Motor Load} = \frac{\text{All Motors Running}}{\text{All Motors Running \& Being Started}} \times 100$$

% Motor Load < 40%, Multiplier = 1.0

If reduced voltage starting is used multiply the skVA by the factor found on the Table 22 and fill in space B6 & B7

| Reduced Voltage Starting Factors  |                  |
|---|------------------|
| Type  | Multiply skVA By |
| Resistor, Reactor, Impedance  |                  |
| 80% Tap   | 0.80             |
| 65% Tap   | 0.65             |
| 50% Tap   | 0.50             |
| 45% Tap   | 0.45             |
| Autotransformer   |                  |
| 80% Tap   | 0.68             |
| 65% Tap   | 0.46             |
| 50% Tap   | 0.29             |
| Y Start, Run  | 0.33             |
| Solid State: Adjustable, consult manufacturer or estimate 300% of full load kVA<br>(Use 1 if no reduced voltage starting aids used) |                  |

Table 22.

If no starting aid is used use 1.0.

Columns B8 can be filled by using information in Section II.

- Use the Effective skVA and Acceptable Voltage Dip numbers to find on TMI the appropriate Generator. Fill in C1, 2, & 3 using the numbers from TMI.

- Generator Set Sizing (VI) can be found by selecting the largest generator set model of Step IV & Step V. (C1)

| Approximate Efficiencies Squirrel Cage Induction Motors |          |                      |
|---|----------|----------------------|
| hp  | kW       | Full-Load Efficiency |
| 5-7½  | 4-6      | 0.83                 |
| 10  | 7.5      | 0.85                 |
| 15  | 11       | 0.86                 |
| 20-25   | 15-19    | 0.89                 |
| 30-50   | 22-37    | 0.90                 |
| 60-75   | 45-56    | 0.91                 |
| 100-300   | 74.6-224 | 0.92                 |
| 350-600   | 261-448  | 0.93                 |

Table 23.

## Genset Selection Considerations

When choosing a genset these factors need to be considered: the load type, the load steps, the load balance, and the generator's temperature rise, pitch, and voltage range.

## Load Types

All loads are different in their power quality needs. A simple incandescent light bulb does not demand high quality power. The amount of light will drop proportionally to voltage, but frequency and voltage waveform free from distortion is not significant. Other loads are sensitive to those type voltage variables. Loads are typically defined as linear or non-linear. One of the first steps is to separate loads into linear and non-linear loads.

## Linear Loads

Linear loads are defined as alternating current (AC) loads which draw current proportional to voltage. They draw current evenly, in sine waveform, throughout the cycle. The load may be resistive, inductive (lagging power factor) or capacitive loading (leading power factor). Regardless of the type, current drawn by a linear load will remain sinusoidal.

|            | <b>Current drawn</b>        | <b>Voltage and Current Waveforms</b> | <b>Examples</b>  |
|------------|-----------------------------|--------------------------------------|--|
| Linear     | Proportional to voltage     | Sine wave                            | Incandescent light bulbs<br>Induction and synchronous motors<br>Electromagnetic devices<br>Resistance heaters                        |
| Non-Linear | Non-proportional to voltage | Pulses                               | Silicon controlled rectifiers<br>Variable speed drives<br>Uninterruptible power supplies<br>Battery chargers<br>Fluorescent lighting |

Table 24.

Conventional electrical formulas for determining electrical characteristics such as voltage drop, current flow measurement, power consumption and heating values are applicable to linear loads and assume there is no distortion of voltage and current waveforms.

Typical linear loads are: Incandescent Lights, Resistance Heaters, Induction and Synchronous Motors, Electromagnetic Devices, and non-saturated transformers.

### **Non-Linear Loads**

An electrical load, which changes or modifies the current or voltage waveform to one that is not sinusoidal is a non-linear load. A load that draws current in pulses is a non-linear load.

The development and application of solid-state electronic components has proliferated non-linear electrical loads. Semi-conductors, particularly silicon controlled rectifiers (SCR's) have the ability to turn "on" or begin conducting at any point during the applied volt wave and draw instantaneous pulses of current. These instantaneous pulse demands result in harmonics, which result in the non-linearity.

Another source of non-sine wave current drawing loads is saturated magnetic core equipment, such as fluorescent ballast transformers and saturated core reactor regulators.

Typical non-linear loads are: Silicon Controlled Rectifiers, Variable Speed Drives, Uninterruptible Power Supplies, Battery Chargers, Computing Equipment, Fluorescent and Gas Discharge Lighting, and Transformers (saturated).

All of these devices require current, which cannot be provided without causing some distortion to the applied source voltage.

### **Harmonic Content**

Deviation from a pure, single sine wave can be expressed as additional sine waves of frequencies, which are a multiple of the generated frequency. These additional frequencies are called harmonics.

Because three-phase generators are magnetically symmetrical, resulting in the cancellation of even harmonics, only odd harmonics are normally of any significance. For example, a 60 Hz generated waveform will contain the 60 Hz fundamental; a 180 Hz, 3rd harmonic; 300 Hz, 5th harmonic; 420 Hz, 7th harmonic and so on. Likewise, a 50 Hz generated waveform will contain the 50 Hz fundamental; a 150 Hz, 3rd harmonic; 250 Hz, 5th harmonic; 350 Hz, 7th harmonic and so on. In general, the higher the harmonic order, the lower the magnitude of the harmonic.

Total Harmonic Distortion (THD) is the measurement of the sum of all harmonics. Most loads will continue to operate with THD at 15-20%. However, loads with sensitive electronic equipment can develop problems with THD greater than 5%.

Non-linear loads cause harmonic currents. These harmonics can cause internal heating of the generator limiting its capability. Generators are designed to provide a given output at rated frequencies of 50 or 60 Hz. It is possible for a generator to carry less than its full rated current and yet overheat because of a harmonic current generated by non-linear load.

In cases where non-linear loads cause increased generator heating, deration or using a low temperature rise generator, which is typically oversized for the kVA requirement, is a technique of compensating for increased generator heating.

| Harmonic Frequency Sequence | Fundamental | 2nd | 3rd | 4th | 5th | 6th | 7th | 8th | 9th |
|-----------------------------|-------------|-----|-----|-----|-----|-----|-----|-----|-----|
|                             | 60          | 120 | 180 | 240 | 300 | 360 | 420 | 480 | 540 |

Table 25.

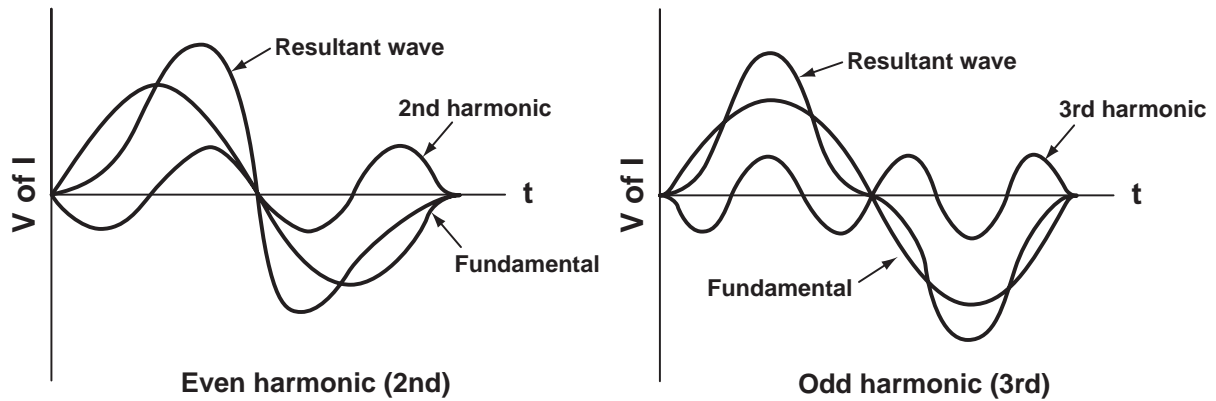

Figure 62.

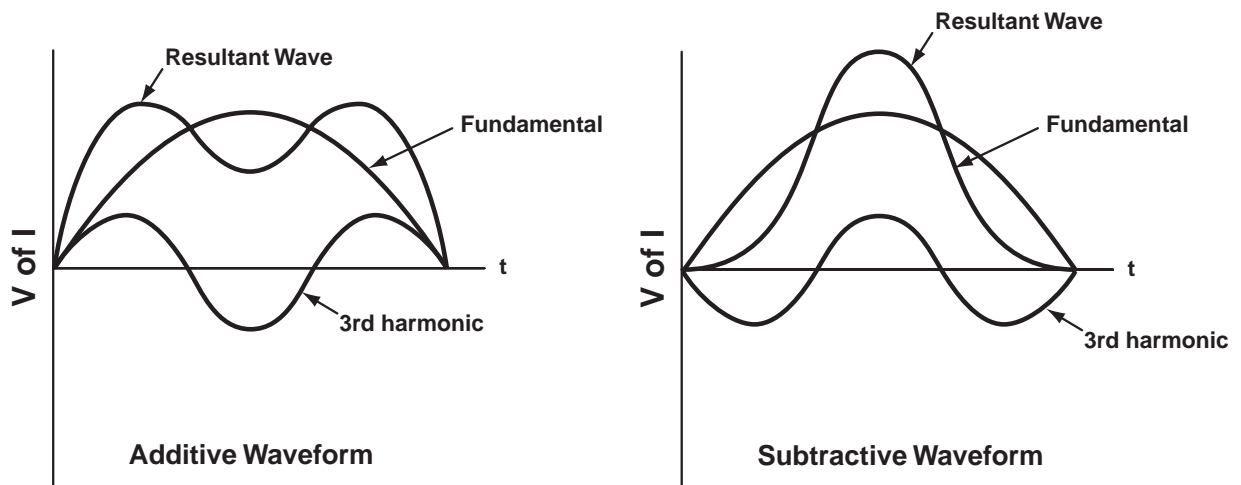

Figure 63.

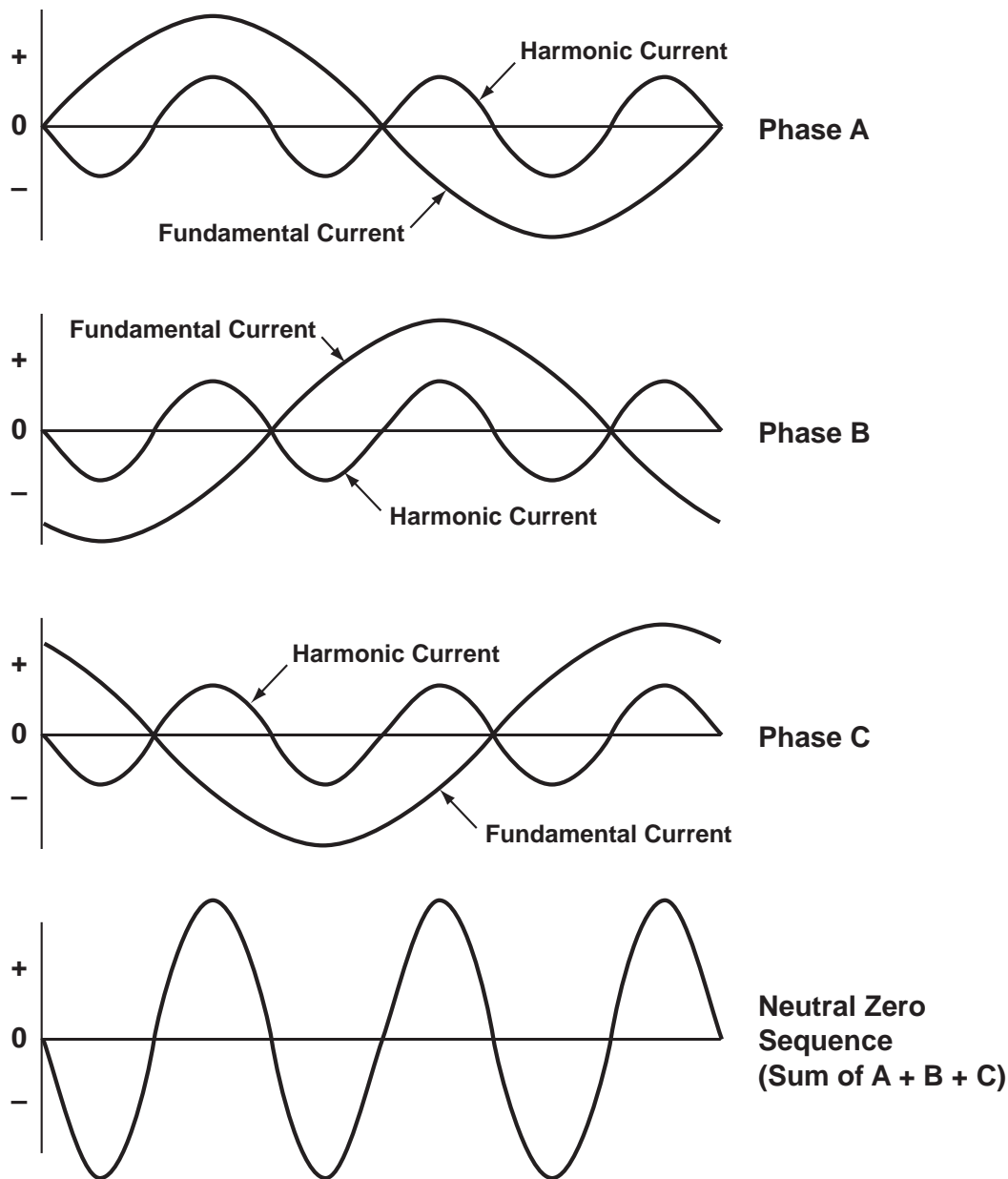

Figure 64.

## Generator Considerations

### Generator Heating

Generators are designed to provide a given output at rated fundamental frequencies of 50 or 60 Hz. Design considerations include making the most effective use of active material to meet acceptable limitations of temperature rise. (More on this topic is found in Engine Ratings section.)

### Generator Reactance Impact

Subtransient reactance ( $X''_d$ ) is a primary indicator of the amount of harmonic distortion to be created by a non-linear load. Current

reacts with impedance to cause voltage drop. The internal reactance of a generator to instantaneous current change is the direct axis subtransient reactance ( $X''_d$ ). A generator with the lowest per unit value of  $X''_d$  at a given load will typically have the lowest value of total harmonic distortion under non-linear load conditions.

The internal reactance of a generator due to line-to-neutral or unbalanced loading is the zero sequence reactance ( $X_0$ ). Any 3rd or triplen harmonic currents produced by the load will not cancel in the neutral and the result is neutral current flow, even with

balanced loads. The 3rd harmonic or triplen harmonic circuit is the same as three single-phase circuits with three parallel line-to-neutral branches sharing common neutral.

Phase conductor heating from the 100% rated neutral 3rd harmonic current and other effects will add approximately 6-7% of additional heat. This relatively high 3rd harmonic would only require 6-7% derating of the generator. It can create distortion of the generator voltage waveform and consequently, could have effects on circuit protective devices and other external circuit elements.

If the load generates 3rd harmonics, the neutral current may become quite large. The generator will actually tolerate a fairly large amount of 3rd harmonic current flow in the neutral with a moderate increase in generator heating.

It is not uncommon for a facility to have large banks of fluorescent lighting and/or single-phase personal computing equipment circuits; creating large amounts of 3rd harmonic current. A neutral conductor larger than the conventional half-rated neutral may be required for these circuits. Fortunately, the design of many of these facilities includes steps to reduce 3rd harmonic current before they reach the generator. Where loads are connected to the generator bus line to line, without a neutral connection or supplied through delta-wye transformer, any triplen harmonics, caused by the load, are not seen by the generator. (See Generator Chapter for additional information.)

This harmonic blocking effect, although desirable to the generator and other parts of the distribution system, can lead to excessive transformer heating.

Generators operating at 400 volts or higher typically supply loads through delta-wye distribution transformers. Exceptions to this may occur, of special concern is where gas discharge lamps are connected directly to the generator bus at line-to-neutral voltage, without benefit of harmonic reduction techniques. Smaller generators (typically below 100 kW) often power the load directly at 208/120 volts with a wye connection. Whenever loads are connected directly to

the generator bus, line-to-neutral, the possibilities of 3rd harmonic current should be considered.

### **Waveform Distortion**

Waveform distortions are greater on a genset than when the loads are connected to utility power. A generator can be compared to others by the level of distortion when running at full load. Since larger loads increase harmonics, full load should be used for accurate comparison. Typically, a 5% or less THD is specified, with no more than 3% from any one harmonic.

The magnitude of a voltage waveform distortion caused by the non-linear current demand of the rectifier/charger is a function of the source impedance. Source impedance is not an easily defined value as generator reactance varies with time following a sudden load change. Generator subtransient reactance ( $X''_d$ ) and subtransient short circuit time constant ( $T''_d$ ) are primary parameters which influence distortion during the short duration of SCR commutation periods.

A standby generator is characteristically of higher impedance than a transformer. Further contributing to the impedance difference is often a significant difference in kVA rating in the two sources. Where as a facility source transformer is frequently sized to carry the total facility load, the standby set is often only sized to carry the emergency or critical loads. A generator may have 5 to 100 times greater subtransient reactance than the normal source transformer.

Consequently, non-linear loads which work fine on utility, may react entirely different when powered by a generator set. Using an oversized generator to reduce reactance may be of some benefit. However, to obtain a significant reduction in reactance is not usually economically feasible. A doubling of generator rating is required to reduce reactance by one-half.

Damping with other loads reduces effective bus reactance. Motors, in particular, act as absorbers of momentary voltage irregularities and reduce harmonic content on the line. Typically, computer room support functions

such as HVAC systems, chilled water systems, fire protection systems, and room lighting must also be connected to the standby generator set. These support systems are often as large or larger than the UPS load. It is frequently very desirable for system operation and distribution reasons to have small, three-phase, continuously running air handler motors in the computer and UPS room sharing a common feeder or power transformer with the UPS.

Resistive loads are effective in minimizing waveform distortion caused by “ringing effect”. Resistance acts as a damper to oscillation in a resonant circuit. Adding a resistance load is one technique used as a treatment to minimize waveform distortion caused by system oscillation. This, however, is only effective if high frequency oscillations are the cause of the problem. If a resistance element is added strictly for treatment purposes, the addition of a capacitor in series with the resistor will reduce fundamental current with minimum effect on high frequency damping.

Adding a low pass filter to the generator output for attenuation of prevailing harmonics is theoretically possible, however, should be considered a last resort option. Practical tuned circuit filters generally represent compromise and may introduce more problems than they solve. Component size and expense are also limiting factors. A better approach is to specify or add filtering or other harmonic attenuating options such as isolation transformers at the source of distortion. Consultation with the UPS supplier will usually reveal such available options.

### **Generator AVR and Excitation**

The voltage regulator must control output voltage of the generator in spite of the load causing a distorted wave shape. Various techniques can be used to accomplish this task.

Three-phase sensing minimizes effects of waveform distortion by providing an average of all three phases at any given instant. Since the SCRs in three-phase rectifier loads do not all “gate on” at the same instant, a minimized distortion average signal of the three phases is processed. In comparison, a single-phase sensing regulator will sense severe distortion

occurring at a given instant during the cycle in one phase. The generator has a three-phase sensing network with a floating neutral as a standard feature. Thus, voltage disturbance in any one phase will shift the neutral but not appreciably effect the voltage to the regulator. Waveform notching is effectively blocked from the regulator.

Regulator circuits must include features to isolate field power control from effects of distortion. If SCRs are used within the regulator, circuits must be used to prevent the distortion from load SCRs interfering with triggering of regulator SCRs.

Generator field power must be filtered to minimize interaction with distortion from the load. A well filtered regulator combined with the inherent inductive filtering of a brushless design generator virtually eliminates this problem. The self-excited generator has a well filtered regulator and excitation system which provides voltage control and stability of equivalent quality to that obtainable with a permanent magnet pilot exciter. It is also fully capable of sustaining excitation during the short circuit periods occurring during the commutation of load SCRs without the benefit of excitation sustaining options. A permanent magnet exciter, while capable of sustaining excitation during a sustained fault condition, has no advantage in providing excitation during the short duration of load SCR commutation. Additional regulator filters or optional features are not required for all generators for UPS applications.

### **Determining Distortion**

A review of the entire generator set distribution system should be made to determine if loads exist which require a source with low distortion waveform. Unless the generator set system is large, it is quite common for other loads to share a common bus with the UPS. If distortion-sensitive loads are suspected, a consultant or distribution system designer with knowledge of where harmonic distortion might be adverse and how to avoid it should be contacted.

To calculate total harmonic distortion at a point in the distribution system requires the consultant to have access to system data such

as subtransient reactance and kVA rating of the generator and any other rotating machines, reactance and resistance's of transformers, cables, and other circuit elements as well as characteristics of the non-linear, distortion-producing device.

The impact of generator pitch on load generated harmonic currents, is highly dependent on the system configuration. This too, is typically not consequential except in special cases.

When supplying non-linear loads which have no neutral connection, the coil pitch has no effect on voltage waveform distortion.

### **Generator Pitch**

Generators do not generate a perfect sine wave. Consequently, there are some harmonics generated.

To produce voltage, a synchronous generator has a direct current (DC) excited structure consisting of alternating north and south magnetic poles, usually on the rotating member of the generator or rotor. The magnetic field produced, sweeps the armature (usually the stator) and induces voltage in coils placed in slots in the armature. When the span of each of these coils is exactly equal to the span of the north to south field poles, the maximum magnetic flux is encompassed by the coil and the maximum voltage is produced. Such a positioning of coils is called an "all pitch" winding. Very few machines are wound full pitch because the winding requires excessive end turn copper and provides little harmonic control. Most generators are fractional pitch windings.

The magnitude and frequency of harmonics generated by the machine will vary with the pitch factor and other design parameters.

### **2/3 Pitch**

The 2/3 pitch winding became popular when manufacturers of small generators wound their machines in delta to combine three-phase and three-wire single. Generators with 2/3 pitch are sometimes thought to have an advantage with non-linear loads because of their low zero sequence reactance ( $X_0$  — a

low reactance to 3rd harmonic zero sequence current.). However, 3rd or triplen harmonics are not normally present in three-phase rectifier loads, such as encountered with UPS or variable speed motor drives, and this characteristic becomes insignificant.

Additionally, a 2/3 pitch generator typically generates higher 5th and 7th harmonics which will cause additional heating in motors due to the higher frequency. In cases with single-phase non-linear loads connected line-to-neutral directly to the generator bus, the 2/3 pitch generator has the potential to minimize, but not totally prevent, 3rd harmonic, (load created) voltage waveform distortion.

### **Non-Linear Loads and 2/3 Pitch**

Non-linear loads generate harmonic currents which cause waveform distortion of the generator. For balanced three-phase loads, distortion is caused by voltage drop due to the harmonic currents in the subtransient reactance of the generator. The subtransient reactance of a generator is not a function of coil pitch. Therefore, the coil pitch does not affect waveform distortion.

The zero sequence reactance of a generator is effective only to currents which flow in the neutral line. Single-phase non-linear loads usually generate high 3rd harmonic currents. When these loads are connected in a balanced manner to a three-phase generator, the 3rd harmonic currents add in the neutral to produce very high neutral currents.

Only where the load is connected directly to the generator does the low zero sequence reactance of a 2/3 pitch generator reduce the voltage waveform distortion. If the load is supplied through a Delta-Wye transformer, the 3rd harmonic currents do not appear in the generator and the 2/3 pitch winding does not help reduce distortion.

### **Paralleling and 2/3 Pitch**

Paralleling generators of different pitch can cause harmonic distortion. A circulating current will flow between paralleled generators if they do not have equal generated voltage waveforms. The flow is dependent upon the voltage difference. There is no advantage to 2/3 pitch winding when paralleling generators.

When paralleling with a utility the 2/3 pitch winding may be a disadvantage due to low zero sequence reactance. Typically, 3rd harmonic current flow in the neutral is of the most significance. Reactors, resistors, or switches can be installed to limit these currents.

### Applications Requiring 2/3 Pitch

When paralleling it is desirable to match the pitch of the existing generators. If the existing generators have 2/3 pitch another generator of matching 2/3 pitch is preferable. Single-phase non-linear loads that are connected in a balanced manner with a neutral connector directly to the generator is also an acceptable application of a 2/3 pitch. An example of this is a 277 V lighting L-N.

### Other Generator Set Selection Considerations

There are times that a facility will have reconnection issues. For example, if a genset is being placed at a site and then moved to another site (with perhaps different applications) the generator set will have to be sized to meet the different requirements of both sites. It is also possible that a customer will know that the facility will be rewired from 480 V to 240 V. Such a situation will require additional consideration when sizing the generator set.

### Voltage Range/Number of Leads

The voltage range and the number of leads needs to be considered so that a generator set can be matched to the job at hand.

Phases are typically arranged in a Wye or Delta configuration.

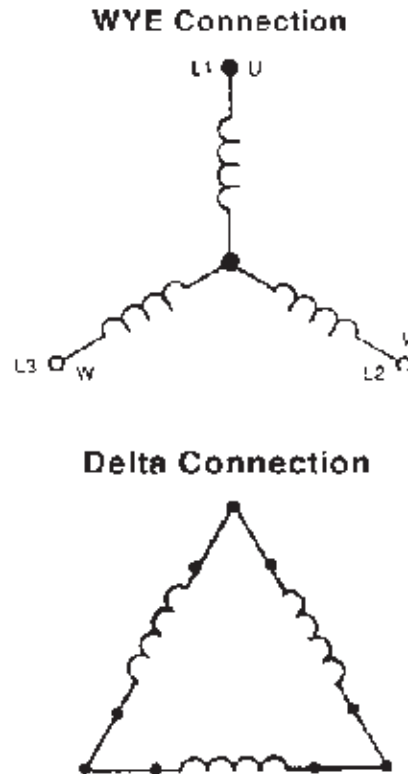

Figure 65.

The wye phase connection has a neutral point, often connected to ground. The Delta does not have a neutral point. The wye configuration is used with three-phase loads or line to line loads. Delta connections are used with single-phase and three-phase loads. Delta connections are found in rural communities where three-phase is not available. A generator can lose up to half of its rating if a delta configuration is hooked to a three-phase system. It is most common for generators to have 12 or 6 leads.

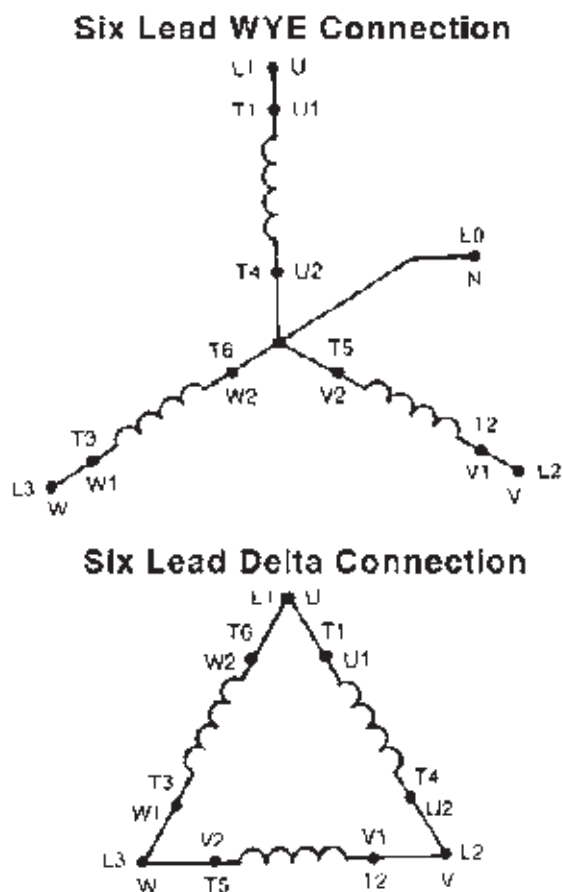

Figure 66.

A twelve-lead WYE connection is the most common in North America. It allows the most versatility because of the multiple configurations allowed.

A twelve-lead, WYE connected, 480 V generator set is usually required for large air compressors, motors, chillers, and air handlers. 240 V is typical for smaller three-phase motors. 120 V is common for office equipment and small single-phase motors.

Before choosing a generator set the current coming in must match the neutral lead. If they do not match, current will be lost in the generator which will weaken the insulation. Alternators would be more susceptible to contamination and failure. Differential protection is a preventative item which checks the current and determines if the neutral matches the incoming current.

### Genset Voltage Selection

Caterpillar identifies three voltage types; low, medium, and high.

Low voltage is the voltage on a local level or part of a site. 600 V or less with 800 kVA for less than 250 V is typical.

Medium voltage is a low level distribution rating. This voltage is distributed to power residential sites and other campuses. 601 V-5000 V with 5-10 MVA is the range for the medium rating.

High voltage runs over regions and is the voltage at a utility or the national grid.

5001 V-15,000 V used with MVA's greater than 10 are considered High Voltage.

Depending on what voltage type is applicable, will help determine the size of the generator needed.

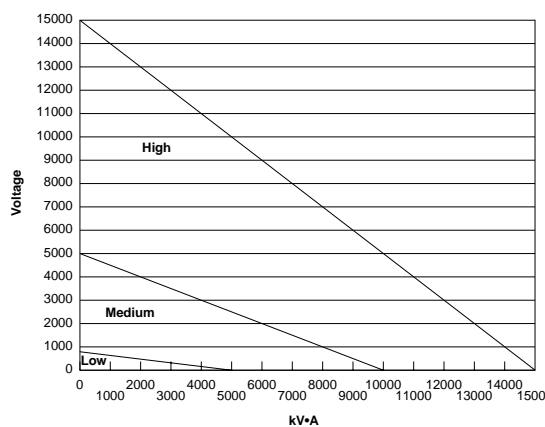

Figure 67.

## Multi-Engine Installations

In some situations, the use of more than one generator set is mandatory. In others, it may prove more economical to have more than one genset. When the load is too large for a single unit, two or more gensets may operate in parallel by being electronically connected.

Critical installations in which the prime power source is a generator set may require additional backup power. A second generator set capable of carrying critical loads should be made available in case of primary set failure and for use during prime set maintenance periods.

Cases where multiple generator set installations may prove more economical are those where there is a large variation in load during the course of a day, week, month, or year. Such variation is typical in plants in which operations are carried on primarily during the day, while only small loads exist at night. The more closely a generator set comes to being fully loaded, the greater the fuel economy per kilowatt produced. Therefore, the use of a small genset to power light, off-hour loads, will often result in long-term fuel economy.

In installations where the load does not vary to the extremes encountered between day and night conditions, it is sometimes profitable to share the load between several small units operating in parallel. One or more of the units may then be shut down when the load is lighter, thereby loading the other units closer to capacity. For example, this type of system is advantageous where load demand is seasonal or when maintenance is necessary and power interruption must be avoided.

## Paralleling

Generator sets can be paralleled to other generator sets or the utility. To operate in parallel, both units must be at the same speed and frequency, operate with the same frequency directional rotation and produce almost exact sine waves. Only after these conditions are met can the units be connected together by a breaker.

Synchronizing lights or meters are used in a manual paralleling operation to confirm both rotational requirements and phase voltage requirements have been met. Automatic, electronically controlled measuring devices are used in automatic paralleling.

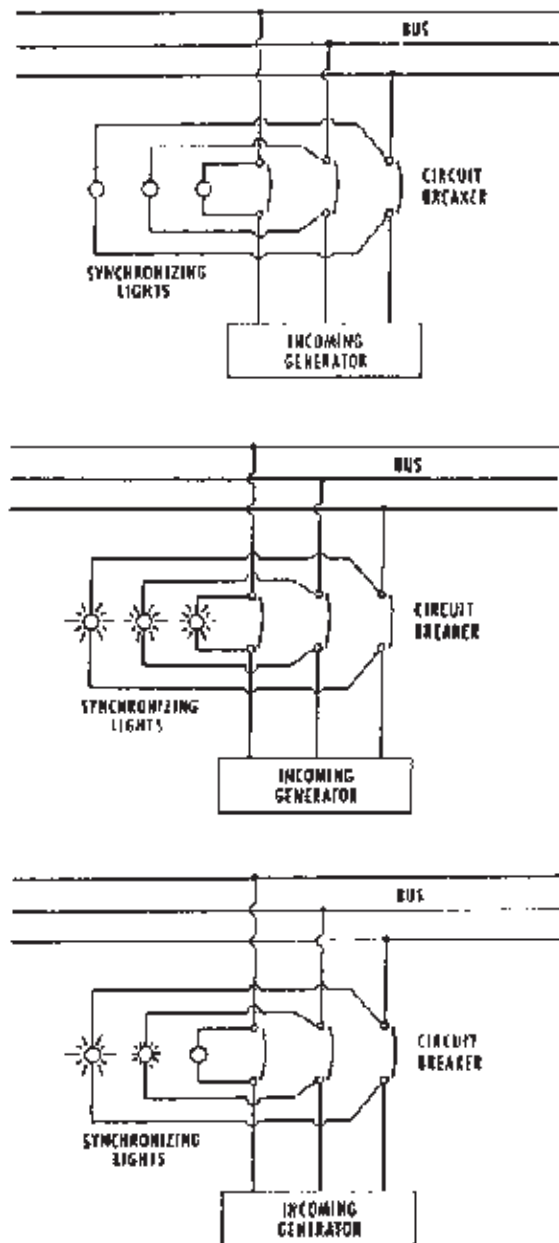

Figure 68.

The synchronized lights have lamps that dim and brighten. When the units are in phase the lights are at their dimmest and the breaker can be tripped to complete the paralleling. If phase sequence is not matched, the lamps will never be light or dark at the same time (see Figure 68). A Synchronizing meter such as a synchroscope (see Figures 69 and 70), can be used instead of the synchronizing lights for synchronizing two or more generator sets. The direction the pointer rotates indicates whether the frequency of the incoming generator is slower or faster than the frequency of the on-line generator.

Similarly, the frequency at which the pointer rotates indicates the magnitude of difference in speed between the generator sets. For paralleling, engine speed is changed until the synchroscope pointer rotates very slowly (less than 10 rpm), again keeping the incoming generator set faster than the on-line generator set. When the pointer is at 0 position, the circuit breaker can be closed (the units are synchronized).

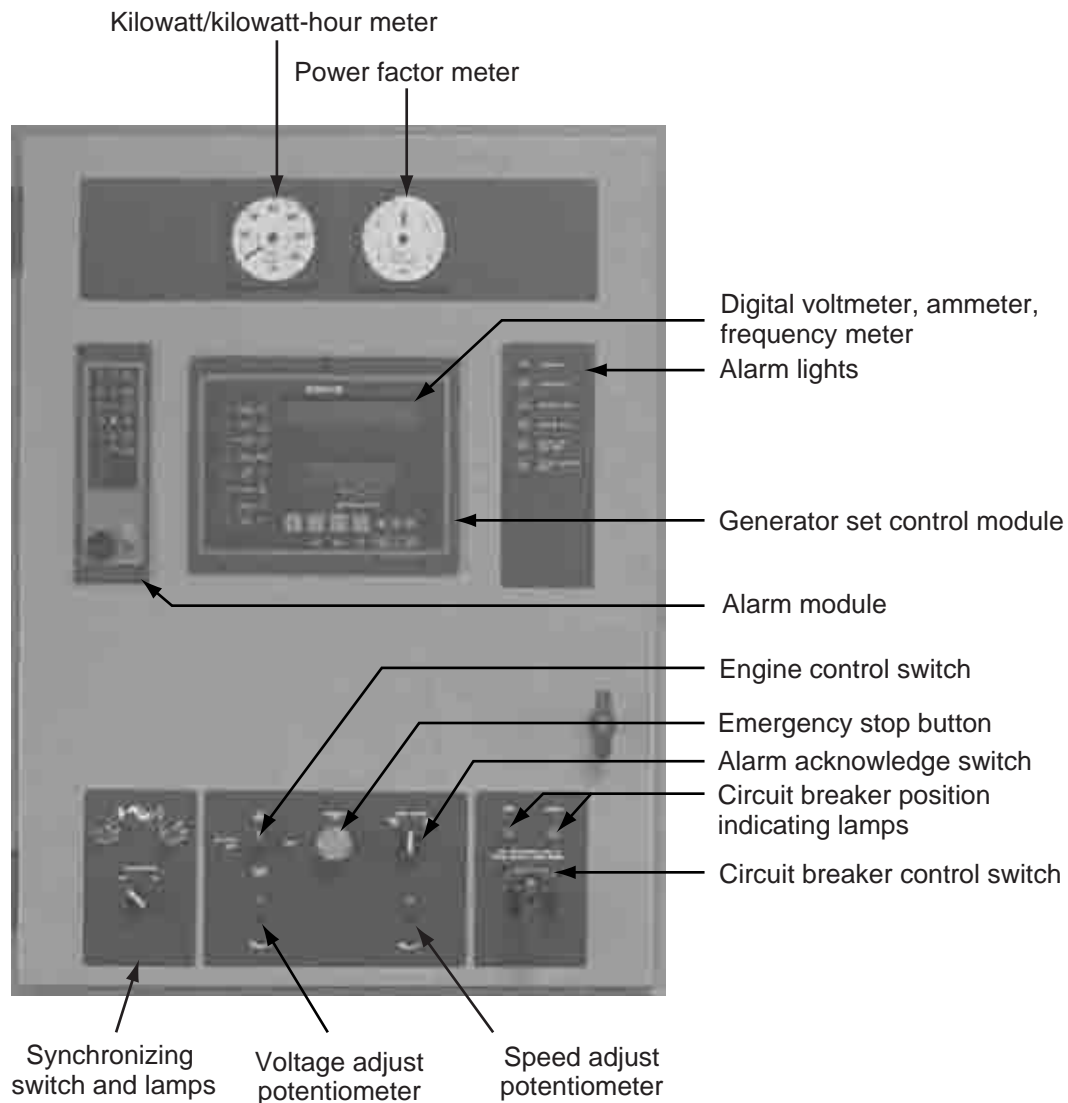

Figure 69.



Figure 70.

Usually identical generator sets operate in parallel without problems; but when paralleling unlike units, consider the effects of:

- **Engine Configuration** — Response to load changes will be affected by engine size, turbocharger, governor type, and adjustment. *Temporary unbalance of kW loads during load change is likely, but can quickly stabilize.*
- **Generator Design** — Circulating currents and harmonic currents add to basic load current, increasing coil temperatures, and causing circuit breaker tripping. *Circulating current is minimized by correct regulator adjustment. Harmonic interaction between generators must be calculated to determine compatibility.*
- **Regulator Design** — Automatic voltage regulation (AVR) of dissimilar design may be used when paralleling generators. *When constant voltage regulators are paralleled with volts-per-Hertz types, imbalance during transient load changes can be anticipated.*

As load is suddenly applied, constant voltage units attempt to supply the total requirement. As the constant voltage generator drops frequency, the volts-per-Hertz unit begins to share load. The temporary load imbalance passes, and kW load is shared between generators.

Once two or more generators are paralleled, it is as though they are mechanically coupled together. They will operate at the same speed but not necessarily have the same power output. Each engine's power contribution is controlled by the relative fuel system output.

### **Droop and Governors**

Droop is when the governor reduces speed with an increasing load. Speed is lowest at full load and highest at no load. Droop is expressed as a percentage of rated speed. A 2-3% droop is typical.

Two **isochronous** units operating in parallel will operate at constant speed (no droop) and be stable at either no load or maximum load. Loads in between will shift randomly between the two generators. Electronic governors can be installed to limit this instability by causing load to be shared more evenly. This strategy is especially effective in allowing many units of unequal size to share load in proportion to their size.

An isochronous generator can also be paralleled with a droop unit. If load is normally at 50% or more then the droop unit can carry the load up to 50%. The synchronous unit then picks up load from 51%-100%. The droop unit can not vary its load because its governor can only have one rack position at the isochronous speed setting.

If the load is normally under 50% of rated, then the isochronous speed generator would be set for rated speed and carry all loads up to 50%. If load exceeds 50%, the isochronous unit slows down and the droop unit picks up the additional load. The isochronous unit will stay at its reduced speed (the same speed as the droop unit), until the load falls below 50%.

If both units are in droop, load share is automatic after they are adjusted to the same hi-idle speed. If no load is connected, each unit will stay at hi-idle speed. If full load is connected, both units must operate at rated speed (governor racks at full load setting). All loads between no load and full load will act accordingly, although frequency will vary. Since the generators must operate at the same speed and a given speed results in one rack position with a droop governor, the generators will operate at approximately the same power output.

### **Regulator Compensation**

When two or more units are operating in parallel, the regulators must control the excitation of the alternators so they share the reactive load. Two ways are: Reactive Droop Compensation and Reactive Differential (cross current) Compensation.

Reactive droop compensation does not require wiring interconnection between regulators. During parallel droop compensation operation, the bus voltage droops (decreases) as the reactive lagging power factor load is increased.

Reactive differential (cross current) compensation requires the addition of interconnecting leads between the current transformer secondaries and allows operation in parallel without voltage droop with reactive load.

Cross current compensation can only be used when all the paralleling current transformers on all the generators delivering power to the bus are in the CT secondary interconnection loop. Because of this requirement, cross current compensation operation *cannot be used when a generating system is operating in parallel with the utility power grid. Utility voltage can vary enough to cause high circulating current in a paralleled generator.* KVAR controllers must be used to adjust generator voltage to match utility and minimize circulating current.

### **Load Control**

There are many decisions which will affect sizing that the facility personnel must make. Load prioritization is a decision which manufacturer expertise can help influence or clarify but not dictate. The end user has to decide upon the load acceptance order, load shedding order, unit starting order, unit shut down order, and/or redundancy.

Load acceptance order determines which loads are critical and must be accepted by which generator.

Load shedding determines which loads are non-critical and shed so that more critical loads can be given priority or additional load.

### **Load Order**

Site personnel must determine the order in which gensets will be started. If #1 genset is **always** started first, it will accumulate hours and maintenance expenses at a high rate compared to the remaining units.

“Slobbering” of the gensets may be another problem encountered. The last unit started may be lightly loaded and said to “slobber”. Slobber is a result of lubricating oil being drawn into the cylinder under low load conditions. This is not conducive to long life and good performance.

A site may require a smaller supply of electricity on the weekend, when the loads are not as large. Gensets of different sizes can be installed where the larger one(s) supply the week and the smaller the weekends.

### **Unit Shutdown**

Unit shutdown order is determined by analyzing which loads can be spared at certain times while other loads are still connected. Again, maintenance implications need to be taken into consideration if it is determined that the same genset will be shutdown first each time.

Redundancy refers to the method of purchasing one or more gensets than needed to operate at full load. This is especially important to loads where a major percentage of it is critical. With additional gensets, downtime can be kept to a minimum because an additional

genset is always free to be connected. Major maintenance can be performed on a genset while the additional one is connected. If two or more additional gensets are present then maintenance can be done on two or more or have a backup for the system when one is being serviced.

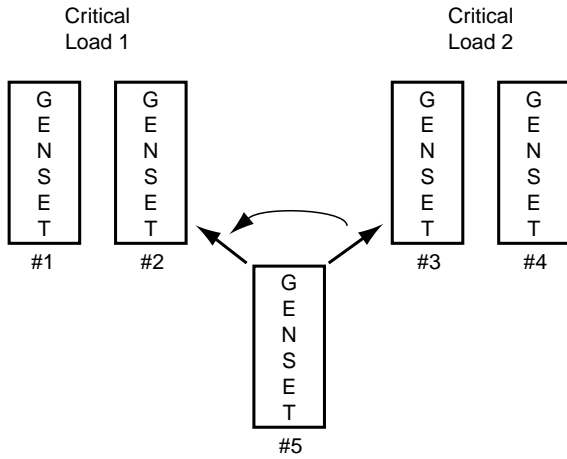

In case one of gensets #1-4 would go down, genset #5 is swing engine which can back up both loads.

Figure 71. Redundancy

# Notes



[www.cat-engines.com](http://www.cat-engines.com)

© 2002 Caterpillar  
All rights reserved.  
Printed in U.S.A.

LEBX0026-01 (01-02)  
Replaces LEBX0026

Materials and specifications are subject to change without notice.

